

# **FURUNO**

## **OPERATOR'S MANUAL**

### *SCANNING SONAR*

Model

**CSH-10**

---

**FURUNO ELECTRIC CO., LTD.**

9-52 Ashihara-cho,  
Nishinomiya, 662-8580, JAPAN

• FURUNO Authorized Distributor/Dealer

All rights reserved. Printed in Japan

Pub. No. OME-13780-B

(DAMI ) CSH-10

A : JUN. 2024

B : JAN. 09, 2025



0 0 0 2 0 0 8 2 9 1 2

# IMPORTANT NOTICES

---

## General

- This manual has been authored with simplified grammar, to meet the needs of international users.
- The operator of this equipment must read and follow the instructions in this manual. Wrong operation or maintenance can void the warranty or cause injury.
- Do not copy any part of this manual without written permission from FURUNO.
- If this manual is lost or worn, contact your dealer about replacement.
- The contents of this manual and the equipment specifications can change without notice.
- The example screens (or illustrations) shown in this manual can be different from the screens you see on your display. The screens you see depend on your system configuration and equipment settings.
- Save this manual for future reference.
- Any modification of the equipment (including software) by persons not authorized by FURUNO will void the warranty.
- The Bluetooth® is a trademark of the Bluetooth SGI, Inc.
- The following concern acts as our importer in Europe, as defined in DECISION No 768/2008/EC.
  - Name: FURUNO EUROPE B.V.
  - Address: Siriusstraat 86, 5015 BT, Tilburg, The Netherlands
- The following concern acts as our importer in UK, as defined in SI 2016/1025 as amended SI 2019/470.
  - Name: FURUNO (UK) LTD.
  - Address: West Building Penner Road Havant Hampshire PO9 1QY, U.K.
- All brand, product names, trademarks, registered trademarks, and service marks belong to their respective holders.

## How to discard this product

Discard this product according to local regulations for the disposal of industrial waste. For disposal in the USA, see the homepage of the Electronics Industries Alliance (<http://www.eiae.org/>) for the correct method of disposal.

## How to discard a used battery

Some FURUNO products have a battery(ies). To see if your product has a battery, see the chapter on Maintenance. If a battery is used, tape the + and - terminals of the battery before disposal to prevent fire, heat generation caused by short circuit.

### In the European Union

The crossed-out trash can symbol indicates that all types of batteries must not be discarded in standard trash, or at a trash site. Take the used batteries to a battery collection site according to your national legislation and the Batteries Directive 2006/66/EU.



### In the USA

The Mobius loop symbol (three chasing arrows) indicates that Ni-Cd and lead-acid rechargeable batteries must be recycled. Take the used batteries to a battery collection site according to local laws.

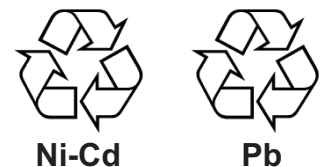



### In the other countries

There are no international standards for the battery recycle symbol. The number of symbols can increase when the other countries make their own recycle symbols in the future.



# SAFETY INSTRUCTIONS

Follow the safety instructions listed below and throughout this manual to prevent damage to your equipment or vessel and to prevent harm to the operator or other personnel on-board. The results of failing to follow the instructions and guidelines outlined herein are listed below.

 <b>DANGER</b>	Indicates a potentially hazardous situation which, if not avoided, could result in death or serious injury.
 <b>WARNING</b>	Indicates a potentially hazardous situation which, if not avoided, could result in death or serious injury.
 <b>CAUTION</b>	Indicates a potentially hazardous situation which, if not avoided, could result in minor or moderate injury.

 Warning, Caution	 Prohibitive Action	 Mandatory Action
--	--	--

 **DANGER**



**Keep away from raise/lower shaft in hull unit when it is moving.**

Gears in hull unit will cause serious injury.

 **WARNING**

 **Do not open the equipment.**

Only qualified personnel should work inside the equipment.

 **Immediately turn off the power at the switchboard if water leaks into the equipment or something is dropped into the equipment.**

Continued use of the equipment can cause fire or electrical shock. Contact a FURUNO agent for service.

 **Immediately turn off the power at the switchboard if the equipment is emitting smoke or fire.**

Continued use of the equipment can cause fire or electrical shock. Contact a FURUNO agent for service.

 **Do not disassemble or modify the equipment.**

Fire, electrical shock or serious injury can result.

 **WARNING**

 **Do not install the equipment where it may be subject to rain or water splash.**

Fire or electrical shock can result if water leaks in the equipment.

 **Do not operate the equipment with wet hands.**

Electrical shock may result.

 **Use the proper fuse.**

Use of a wrong fuse can result in damage to the equipment or cause fire.

 **Do not place liquid-filled containers on the top of the equipment.**





Fire or electrical shock can result if a liquid spills into the equipment.



 **Handle the transducer carefully.**

Do not swing the transducer or strike it against an object, to prevent damage to the transducer.

 **Do not transmit the transducer when it is out of water (for example, when dry-docked), to prevent damage to the transducer.**



 <b>CAUTION</b>
 <b>Do not exceed 20 knots with the transducer lowered and do not exceed 18 knots when lowering or raising the transducer.</b>  The transducer may become damaged.
 <b>Check the water depth before lowering the transducer.</b>  If the depth is too shallow, the transducer may touch the seabed, resulting in damage to the transducer.
 <b>Do not connect/disconnect the cables from a unit while the unit is powered.</b>  The unit may be damaged.
 <b>Turn off the power switch on the hull unit before manually raising or lowering the transducer (with the ratchet wrench).</b>  Bodily injury may result if the ratchet wrench rotates unexpectedly, because the raise/lower motor may start up.

 <b>CAUTION</b>
 Observe the following precautions when using industrial use lubricant.  Precautions <ul style="list-style-type: none"> <li>• Keep lubricant away from eyes. Wear protective goggles when working with the lubricant. The lubricant can cause inflammation of the eyes.</li> <li>• Do not touch the lubricant. Wear protective gloves when working with the lubricant. The lubricant can cause inflammation of the skin.</li> <li>• Do not ingest the lubricant. Diarrhea and vomiting may result.</li> <li>• Keep the lubricant out of reach of children.</li> </ul> Emergency procedures <ul style="list-style-type: none"> <li>• If the lubricant enters eyes, flush with clean water about 15 minutes. Consult a physician.</li> <li>• If the lubricant contacts skin, flush area with clean water.</li> <li>• If the lubricant is ingested, see a physician immediately.</li> </ul> Disposal of lubricant and its container Dispose of the lubricant and its container in accordance with local regulations. If you are unclear about the disposal procedure, contact a FURUNO agent or dealer for advice.

**WARNING LABEL**

A warning label is attached to the processor unit, the transceiver unit and the hull unit of the system. Do not remove any label. If a label is missing or damaged, contact a FURUNO agent or dealer about replacement.

 <b>WARNING 警告</b>
 To avoid electrical shock, do not remove cover. No user-serviceable parts inside. 严禁打开本设备 本设备使用高压电，可能会导致触电。 任何维修工作需由有资质的技术人员进行， 感電の恐れあり。 サービスマン以外の方はカバーを開けないで下さい。内部には高電圧部分が 数多くあり、万一さわると危険です。

Name: Warning Label(ECJ)  
 Type: 10-092-6546-0  
 Code No.: 100-447-850-10  
 Location: Processor・Transceiver unit

 <b>WARNING 警告</b>
 Moving main shaft can pinch and cut. Keep hands clear during operation. Turn off power before servicing. 移动的主轴可能会夹住你的双手并切伤。 操作时要注意自己的双手。 在维修之前，请关闭电源。 上下動シャフト部分は手を挟む恐れあり。 稼働中は手を近づけないこと。 サービスを行う前は電源を切ること。

Name: Finger Warning Label  
 Type: 10-092-5504-0  
 Code No.: 100-447-190-10  
 Location: Hull unit

# TABLE OF CONTENTS

---

<b>FOREWORD .....</b>	<b>vii</b>
<b>SYSTEM CONFIGURATION .....</b>	<b>xiii</b>
<b>1. OPERATIONAL OVERVIEW .....</b>	<b>1-1</b>
1.1 Controls Overview .....	1-1
1.1.1 Control unit SCU-002 .....	1-1
1.1.2 Remote controller FSV-854-MK2 (Option) .....	1-3
1.1.3 Remote controller SCU-001 (Option) .....	1-3
1.1.4 Small switch box SCU-003 (Option) .....	1-4
1.2 Basic Menu Operation .....	1-5
1.3 Basic Operating Procedure .....	1-8
1.3.1 How to turn on the power .....	1-8
1.3.2 How to lower the transducer .....	1-9
1.3.3 How to start transmission .....	1-10
1.3.4 How to adjust the back lighting of the control panel .....	1-10
1.3.5 How to select the display mode .....	1-11
1.3.6 How to select the detecting range .....	1-14
1.3.7 How to adjust the gain .....	1-14
1.3.8 How to raise the transducer, turn off the power .....	1-15
1.4 Tilt Angle .....	1-16
1.4.1 How to set the tilt angle .....	1-16
1.4.2 How to turn automatic tilt on/off .....	1-16
1.4.3 How to distinguish fish echoes from the bottom .....	1-18
1.4.4 Tilt angle for surface fish .....	1-19
1.4.5 Suitable tilt angle .....	1-19
1.5 Range and Bearing to a Target .....	1-20
1.6 Software Function Keys .....	1-20
<b>2. FINE TUNING THE SONAR PICTURE .....</b>	<b>2-1</b>
2.1 How to Eliminate Unwanted Echoes .....	2-1
2.2 How to Suppress Bottom Tail .....	2-2
2.2.1 How to set AGC near/far .....	2-2
2.2.2 How to adjust the pulse length .....	2-2
2.2.3 How to suppress the unwanted echoes (noise suppression) .....	2-2
2.3 How to Suppress Bottom Echoes and Sea Clutters in Shallow Fishing Grounds .....	2-3
2.4 How to Reject Sonar Interference and Noise .....	2-4
2.4.1 How to identify noise source .....	2-4
2.4.2 How to reject noise with the interference rejector .....	2-4
2.4.3 How to reject noise with the noise limiter .....	2-4
2.4.4 How to reject interference with transmission interval .....	2-5
2.4.5 How to shift the transmission frequency .....	2-5
2.4.6 How to use echo average .....	2-6
2.5 How to Choose Beamwidth .....	2-6
2.6 How to Remove Weak Echoes .....	2-6
<b>3. ADVANCED SONAR OPERATION .....</b>	<b>3-1</b>
3.1 How to Track a School of Fish (Target Lock) .....	3-1
3.1.1 Fish mode .....	3-1
3.1.2 Target mark mode .....	3-2
3.2 How to Detect Schools of Fish Audibly .....	3-2
3.2.1 How to turn the audio on/off .....	3-3
3.2.2 How to set the audio bearing .....	3-3

3.2.3	How to adjust the audio volume .....	3-4
3.3	The Fish Alarm .....	3-5
3.3.1	How to activate/deactivate the fish alarm .....	3-5
3.3.2	How to set alarm level .....	3-6
3.4	How to Measure the Speed of School of Fish .....	3-6
3.4.1	How to enter a fish mark .....	3-6
3.4.2	How to delete fish marks .....	3-8
3.5	How to Relocate a School of Fish .....	3-8
3.6	Event Mark .....	3-9
3.6.1	How to enter an event mark .....	3-9
3.6.2	How to delete an event mark .....	3-10
3.7	How to Compare Concentration of School of Fish .....	3-10
3.7.1	Using the function keys .....	3-10
3.7.2	Using the [Select Mark] window .....	3-12
3.8	Select Mark Window .....	3-13
3.9	Net Course Mark .....	3-13
3.10	Net Data .....	3-14
3.10.1	How to set the net shooting history .....	3-14
3.10.2	How to use the net shoot mark .....	3-14
<b>4.</b>	<b>FISH FINDER MODE .....</b>	<b>4-1</b>
4.1	Fish Finder Display Overview .....	4-1
4.2	How to Select a Display Range .....	4-1
4.3	How to Adjust the Gain .....	4-2
4.4	How to Select Picture Advance Speed .....	4-3
4.5	How to Measure Depth and Distance .....	4-3
4.6	How to Suppress Interference .....	4-4
4.7	How to Reject Low Level Noise (Clutter) .....	4-4
4.8	How to Erase Weak Echoes .....	4-5
4.9	How to Adjust TVG (Time Varied Gain) .....	4-5
4.10	Smoothing .....	4-6
4.11	How to Remove Unwanted Echoes Near the Surface .....	4-7
4.12	TX and RX Settings .....	4-7
<b>5.</b>	<b>NUMERIC AND GRAPHIC DATA DISPLAY AREA .....</b>	<b>5-1</b>
5.1	Numeric and Graphic Data Display .....	5-1
5.2	Numeric/Graphic Data Description .....	5-2
<b>6.</b>	<b>HOW TO CUSTOMIZE THE SONAR .....</b>	<b>6-1</b>
6.1	Function Keys .....	6-1
6.1.1	How to operate the function keys .....	6-1
6.1.2	How to assign menu items to the function keys .....	6-2
6.2	User Programs .....	6-3
6.2.1	How to select a user program .....	6-4
6.2.2	How to set the user program .....	6-4
6.3	How to Restore Scan Settings (Range, Tilt Angle, Gain) .....	6-5
6.3.1	How to preset the range, tilt angle, and gain values .....	6-5
6.3.2	How to restore the settings for scanning .....	6-6
6.4	Remote Controller FSV-854-MK2 (Option) .....	6-7
6.5	Remote Controller SCU-001 (Option) .....	6-7
6.5.1	How to set up Bluetooth® pairing .....	6-8
6.5.2	How to cancel pairing .....	6-10
6.5.3	How to change the functions assigned to the function keys .....	6-10
6.5.4	How to check currently assigned functions .....	6-11

## TABLE OF CONTENTS

<b>7. DATA RECORD/PLAY</b> .....	<b>7-1</b>
7.1 How to Specify Where to Save Still and Motion Images .....	7-1
7.2 How to Save a Still Image .....	7-2
7.3 How to Show the Saved Still Image .....	7-3
7.4 How to Save Motion Images .....	7-5
7.5 How to Play Back Motion Images .....	7-6
7.6 How to Delete Files .....	7-7
<b>8. HOW TO INTEREPRET THE DISPLAY</b> .....	<b>8-1</b>
8.1 Bottom Echo.....	8-1
8.2 School of Fish .....	8-2
8.3 Sea Surface Reflections.....	8-3
8.4 Tracks .....	8-3
8.5 False Echo by Sidelobe .....	8-4
8.6 Noise and Interference.....	8-4
<b>9. OTHER SETTINGS</b> .....	<b>9-1</b>
9.1 [USER PROG] Menu.....	9-1
9.2 [Sonar] Menu.....	9-5
9.2.1 [Sonar] menu.....	9-5
9.2.2 [Mark] menu .....	9-6
9.3 [Sounder] Menu.....	9-7
9.4 [System] Menu .....	9-8
9.4.1 [Record] menu.....	9-8
9.4.2 [Test] menu .....	9-8
9.4.3 [InitSetting] menu .....	9-9
<b>10. MAINTENANCE</b> .....	<b>10-1</b>
10.1 Periodic Maintenance.....	10-1
10.2 Hull Unit Maintenance .....	10-2
10.2.1 Greasing the gears.....	10-3
10.2.2 How to replace the gasket.....	10-4
10.2.3 How to check the disc damper .....	10-6
10.3 How to Replace the Fuse.....	10-7
10.4 How to Replace the Battery .....	10-7
10.5 Trackball Maintenance .....	10-7
10.6 Troubleshooting .....	10-9
10.7 Alarm and Warning .....	10-10
10.8 Error Codes.....	10-12
10.9 Status Messages.....	10-12
10.10 Tests.....	10-12
10.10.1 How to use the test menu .....	10-12
10.10.2 Operation test.....	10-13
10.10.3 Board test.....	10-16
10.10.4 Fan monitor test .....	10-17
10.10.5 Panel test / SIO test .....	10-18
10.10.6 Remote controller test.....	10-19
10.11 How to Retract the Transducer Manually .....	10-21
10.12 How to Check the Brake In the Hull Unit .....	10-22
<b>APPX. 1 MENU TREE</b> .....	<b>AP-1</b>
<b>APPX. 2 ERROR CODE LIST</b> .....	<b>AP-4</b>
<b>APPX. 3 DATA INPUT REQUIREMENTS</b> .....	<b>AP-7</b>
<b>APPX. 4 BRAKE TEST SHEET</b> .....	<b>AP-8</b>
<b>SPECIFICATIONS</b> .....	<b>SP-1</b>
<b>INDEX</b> .....	<b>IN-1</b>

# FOREWORD

---

## A Word to the Owner

Congratulations on your choice of the FURUNO CSH-10 Color Scanning Sonar.

Since 1948, FURUNO Electric Company has enjoyed an enviable reputation for innovative and dependable marine electronics equipment. This dedication to excellence is furthered by our extensive global network of agents and dealers.

Your equipment is designed and constructed to meet the rigorous demands of the marine environment. However, no machine can perform its intended function unless properly installed and maintained. Please carefully read and follow the operation and maintenance procedures set forth in this manual.

We would appreciate hearing from you, the end-user, about whether we are achieving our goal. Thank you for considering and purchasing FURUNO equipment.

## Features

The FURUNO CSH-10 Color Scanning Sonar is a full-circle electronic scanning sonar. The CSH-10 consists of a control unit, processor unit, transceiver unit, hull unit and monitor (supplied locally), and detects and instantaneously displays schools of fish and underwater conditions.

Some of the prominent features of the CSH-10 are as follows.

- Increased detection range and the ability to scan a full-circle in one sweep.
- Motion compensation function ensures stable video display.
- Vivid 32-color display assists in recognition of bottom, and concentration and distribution of schools of fish.
- Frequently used functions can be set from the control panel, while other functions can be set using menu operations.
- Tilt indicator allows the fish detection angle to be monitored.
- Transducer position indicator shows the transducer protrusion position at a glance.
- Target lock feature tracks schools of fish.
- Store up to 10 sets of settings to quickly change your setup for varying tasks.
- Save and replay echo images.
- Multiple marks and indications to help you identify fish finder data and voyage data at a glance.
- Various diagnostics.
- Use of remote controller (wireless, wired: option).

## Interference suppression

When another ship asks you to suppress interference, the measures based on 1) Broadband fish finder or sonar, 2) Multiple frequency fish finder or sonar, 3) Single frequency fish finder or sonar equipment priority should be performed. The following measures can be taken.

- Shift the transmission frequency (see page 2-5).
- Reduce the transmission power output (see page 2-3).
- Reject interference with transmission interval (see page 2-5).

The CSH-10 is a 3) single frequency sonar, therefore it has the lowest priority.

## Standards used in this manual

- Key names are shown in boldface type.
- Menu items and on-screen indications are shown in brackets.
- Messages shown on the display are enclosed in quotations.
- The colors mentioned in this manual are the default colors. Your colors may be different.
- The operating procedures are described using SCU-002, unless otherwise indicated.
- Pressing the left button is indicated as “click”, and pressing the right button is indicated as “right click”.
- “Drag and drop” in this manual means that moving the cursor while holding down the left button, and releasing the left button at another location.
- In this manual, the menu opening and closing procedures are described as "Open the menu" and "Close the menu".
- The operation to select and confirm a menu item or setting is described in this manual as "Select [xxx]". This indicates the following two operational procedures.
  - 1) Rotate the wheel knob or the trackball to select the [xxx].
  - 2) Press the wheel knob or the left button.

## Licensed software

This product includes software licensed under BSD-3 Clause and others. Please refer to the following for details on the terms of the software.

### Intel-socfpga-hwlib

Copyright 2013-2020 Intel Corporation. All Rights Reserved.

Redistribution and use in source and binary forms, with or without modification, are permitted provided that the following conditions are met:

1. Redistributions of source code must retain the above copyright notice, this list of conditions and the following disclaimer.
2. Redistributions in binary form must reproduce the above copyright notice, this list of conditions and the following disclaimer in the documentation and/or other materials provided with the distribution.
3. Neither the name of the copyright holder nor the names of its contributors may be used to endorse or promote products derived from this software without specific prior written permission.

THIS SOFTWARE IS PROVIDED BY THE COPYRIGHT HOLDERS AND CONTRIBUTORS "AS IS" AND ANY EXPRESS OR IMPLIED WARRANTIES, INCLUDING, BUT NOT LIMITED TO, THE IMPLIED WARRANTIES OF MERCHANTABILITY AND FITNESS FOR A PARTICULAR PURPOSE ARE DISCLAIMED. IN NO EVENT SHALL THE COPYRIGHT HOLDER OR CONTRIBUTORS BE LIABLE FOR ANY DIRECT, INDIRECT, INCIDENTAL, SPECIAL, EXEMPLARY, OR CONSEQUENTIAL DAMAGES (INCLUDING, BUT NOT LIMITED TO, PROCUREMENT OF SUBSTITUTE GOODS OR SERVICES; LOSS OF USE, DATA, OR PROFITS; OR BUSINESS INTERRUPTION) HOWEVER CAUSED AND ON ANY THEORY OF LIABILITY, WHETHER IN CONTRACT, STRICT LIABILITY, OR TORT (INCLUDING NEGLIGENCE OR OTHERWISE) ARISING IN ANY WAY OUT OF THE USE OF THIS SOFTWARE, EVEN IF ADVISED OF THE POSSIBILITY OF SUCH DAMAGE.

Altera-SoCFPGA-HardwareLib-MPL

Altera MPL preloader, configured for use with SDMMC/Connectal. (The initial commit is the unmodified sourcecode from Altera)

The original source was extracted from: altera/14.1/embedded/examples/software/Altera-SoCFPGA-HardwareLib-MPL.tar.gz and has BSD copyright with the additional restriction: "This software may only be used to run on Altera products, or to program Altera devices."

All subsequent edits by Cambridgehackers are under the same copyright.

**Open SSL copyright information**

## LICENSE ISSUES

The OpenSSL toolkit stays under a double license, i.e. both the conditions of the OpenSSL License and the original SSLeay license apply to the toolkit. See below for the actual license texts.

OpenSSL License

=====  
Copyright (c) 1998-2019 The OpenSSL Project. All rights reserved.

Redistribution and use in source and binary forms, with or without modification, are permitted provided that the following conditions are met:

- 1) Redistributions of source code must retain the above copyright notice, this list of conditions and the following disclaimer.
- 2) Redistributions in binary form must reproduce the above copyright notice, this list of conditions and the following disclaimer in the documentation and/or other materials provided with the distribution.
- 3) All advertising materials mentioning features or use of this software must display the following acknowledgment: "This product includes software developed by the OpenSSL Project for use in the OpenSSL Toolkit. (<http://www.openssl.org/>)"
- 4) The names "OpenSSL Toolkit" and "OpenSSL Project" must not be used to endorse or promote products derived from this software without prior written permission. For written permission, please contact [openssl-core@openssl.org](mailto:openssl-core@openssl.org).
- 5) Products derived from this software may not be called "OpenSSL" nor may "OpenSSL" appear in their names without prior written permission of the OpenSSL Project.
- 6) Redistributions of any form whatsoever must retain the following acknowledgment: "This product includes software developed by the OpenSSL Project for use in the OpenSSL Toolkit (<http://www.openssl.org/>)"

THIS SOFTWARE IS PROVIDED BY THE OpenSSL PROJECT ``AS IS'' AND ANY EXPRESSED OR IMPLIED WARRANTIES, INCLUDING, BUT NOT LIMITED TO, THE IMPLIED WARRANTIES OF MERCHANTABILITY AND FITNESS FOR A PARTICULAR PURPOSE ARE DISCLAIMED. IN NO EVENT SHALL THE OpenSSL PROJECT OR ITS CONTRIBUTORS BE LIABLE FOR ANY DIRECT, INDIRECT, INCIDENTAL, SPECIAL, EXEMPLARY, OR CONSEQUENTIAL DAMAGES (INCLUDING, BUT NOT LIMITED TO, PROCUREMENT OF SUBSTITUTE GOODS OR SERVICES; LOSS OF USE, DATA, OR PROFITS; OR BUSINESS INTERRUPTION) HOWEVER CAUSED AND ON ANY THEORY OF LIABILITY, WHETHER IN CONTRACT, STRICT LIABILITY, OR TORT (INCLUDING NEGLIGENCE OR OTHERWISE) ARISING IN ANY WAY OUT OF THE USE OF THIS SOFTWARE, EVEN IF ADVISED OF THE POSSIBILITY OF SUCH DAMAGE.

=====

## FOREWORD

This product includes cryptographic software written by Eric Young (eay@cryptsoft.com). This product includes software written by Tim Hudson (tjh@cryptsoft.com).

### Original SSLeay License

Copyright (C) 1995-1998 Eric Young (eay@cryptsoft.com)  
All rights reserved.

This package is an SSL implementation written by Eric Young (eay@cryptsoft.com). The implementation was written so as to conform with Netscapes SSL.

This library is free for commercial and non-commercial use as long as the following conditions are aheared to. The following conditions apply to all code found in this distribution, be it the RC4, RSA, lhash, DES, etc., code; not just the SSL code. The SSL documentation included with this distribution is covered by the same copyright terms except that the holder is Tim Hudson (tjh@cryptsoft.com).

Copyright remains Eric Young's, and as such any Copyright notices in the code are not to be removed. If this package is used in a product, Eric Young should be given attribution as the author of the parts of the library used. This can be in the form of a textual message at program startup or in documentation (online or textual) provided with the package.

Redistribution and use in source and binary forms, with or without modification, are permitted provided that the following conditions are met:

- 1) Redistributions of source code must retain the copyright notice, this list of conditions and the following disclaimer.
- 2) Redistributions in binary form must reproduce the above copyright notice, this list of conditions and the following disclaimer in the documentation and/or other materials provided with the distribution.
- 3) All advertising materials mentioning features or use of this software must display the following acknowledgement:  
"This product includes cryptographic software written by Eric Young (eay@cryptsoft.com)"  
The word 'cryptographic' can be left out if the rouines from the library being used are not cryptographic related :-).
- 4) If you include any Windows specific code (or a derivative thereof) from the apps directory (application code) you must include an acknowledgement: "This product includes software written by Tim Hudson (tjh@cryptsoft.com)"

THIS SOFTWARE IS PROVIDED BY ERIC YOUNG ``AS IS" AND ANY EXPRESS OR IMPLIED WARRANTIES, INCLUDING, BUT NOT LIMITED TO, THE IMPLIED WARRANTIES OF MERCHANTABILITY AND FITNESS FOR A PARTICULAR PURPOSE ARE DISCLAIMED. IN NO EVENT SHALL THE AUTHOR OR CONTRIBUTORS BE LIABLE FOR ANY DIRECT, INDIRECT, INCIDENTAL, SPECIAL, EXEMPLARY, OR CONSEQUENTIAL DAMAGES (INCLUDING, BUT NOT LIMITED TO, PROCUREMENT OF SUBSTITUTE GOODS OR SERVICES; LOSS OF USE, DATA, OR PROFITS; OR BUSINESS INTERRUPTION) HOWEVER CAUSED AND ON ANY THEORY OF LIABILITY, WHETHER IN CONTRACT, STRICT LIABILITY, OR TORT (INCLUDING NEGLIGENCE OR OTHERWISE) ARISING IN ANY WAY OUT OF THE USE OF THIS SOFTWARE, EVEN IF ADVISED OF THE POSSIBILITY OF SUCH DAMAGE.

The licence and distribution terms for any publically available version or derivative of this code cannot be changed. i.e. this code cannot simply be copied and put under another distribution licence [including the GNU Public Licence.]



## **CE/UKCA declaration**

With regards to CE/UKCA declarations, please refer to our website ([www.furuno.com](http://www.furuno.com)), for further information about RoHS conformity declarations.

## **Disclosure of Information about China RoHS**

With regards to China RoHS information for our products, please refer to our website ([www.furuno.com](http://www.furuno.com)).

# SYSTEM CONFIGURATION

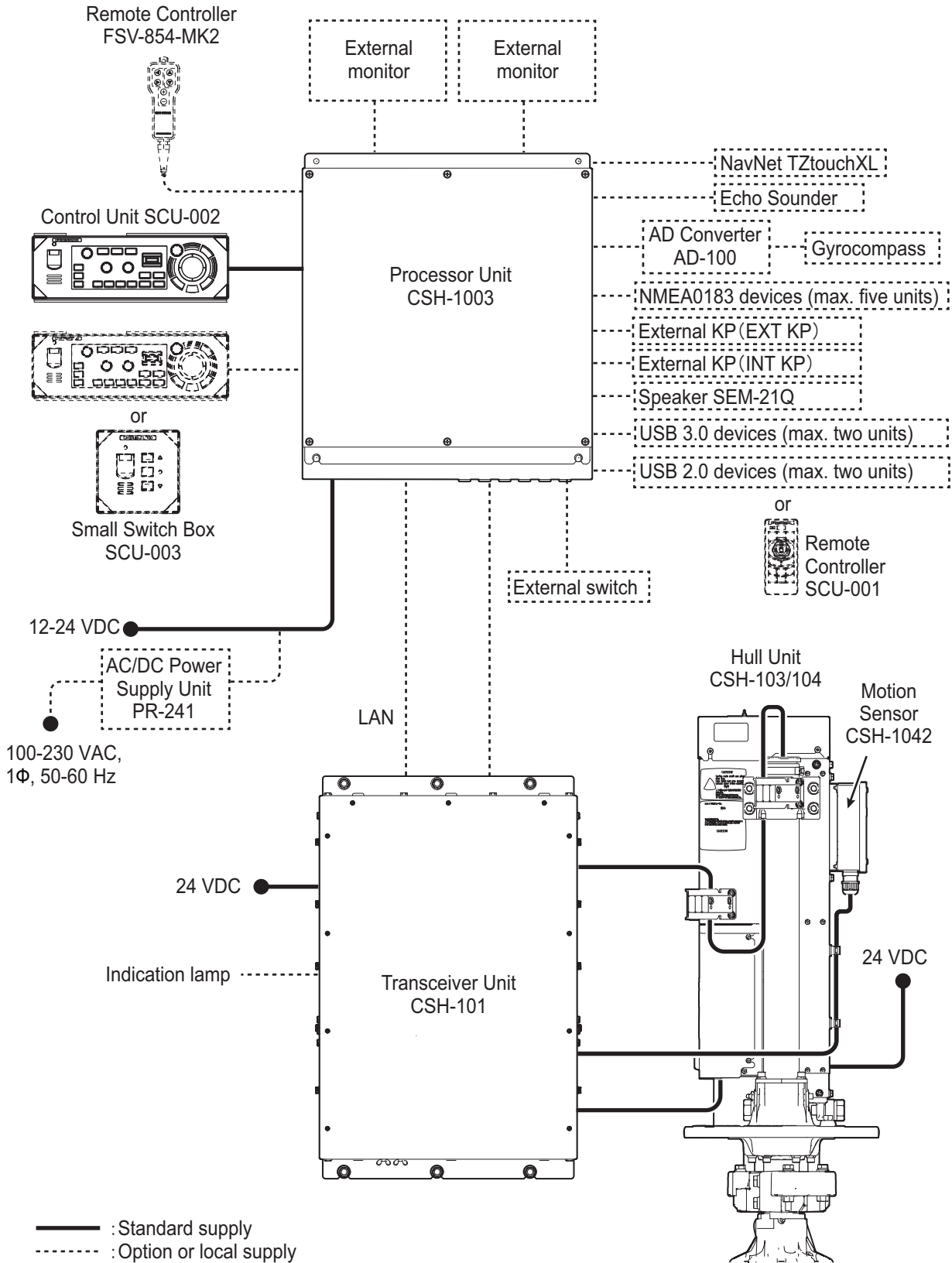

**Note:** The CSH-10 can use the navigation data input to the LAN2 port via the NavNet TZtouchXL.

# 1. OPERATIONAL OVERVIEW

## 1.1 Controls Overview

### 1.1.1 Control unit SCU-002

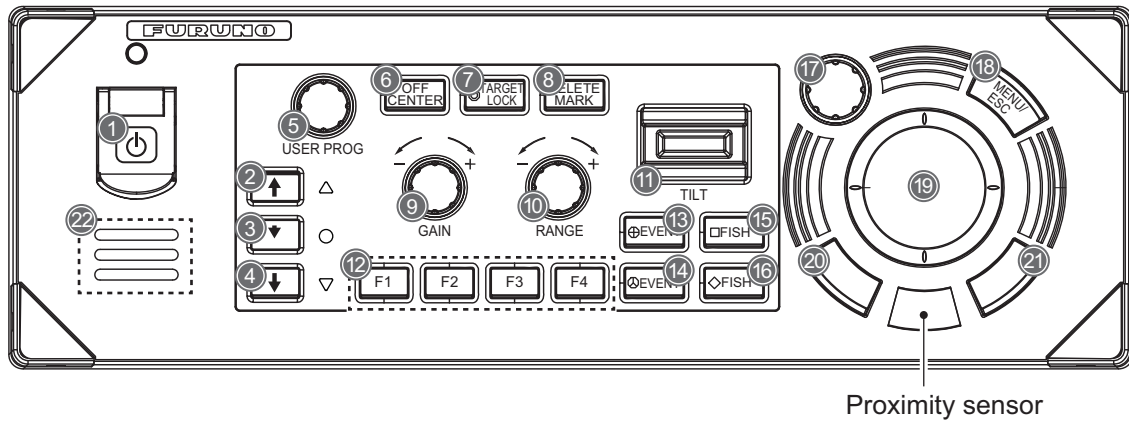

No.	Key/Control	Description
1		Turns on/off the power of the system.
2		Completely retracts the transducer.
3		Not used.
4		Completely lowers the transducer.
5	USER PROG	Selects user-programmed settings (P1 to P10).
6	OFF CENTER	Moves the own ship mark to the cross-hair cursor position.
7	TARGET LOCK	Enters the target lock mark.
8	DELETE MARK	<ul style="list-style-type: none"> <li><b>Short press:</b> Erases the event mark or fish mark selected by the cross-hair cursor.</li> <li><b>Long press:</b> Erases all marks (event mark1&amp;2, and fish mark1&amp;2).</li> </ul>
9	GAIN	Adjusts the gain.
10	RANGE	Adjusts the range.
11	TILT	Sets the tilt angle from the sea surface.
12	F1/F2/F3/F4	Recall the functions assigned for each key. <b>Note:</b> See section 6.1 to check the factory default assigned functions.
13	EVENT	Enters a new event mark 1.
14	EVENT	Enters a new event mark 2.
15	FISH	Enters a new fish mark 1.
16	FISH	Enters a new fish mark 2.

## 1. OPERATIONAL OVERVIEW

No.	Key/Control	Description
17	Wheel knob	<ul style="list-style-type: none"> <li>• <b>Turn:</b> Selects the menu item.</li> <li>• <b>Turn:</b> Adjusts the setting values.</li> <li>• <b>Turn:</b> Adjusts the gain, range, tilt angle, or sets user-programmed settings.</li> <li>• <b>Short press:</b> Confirms the selection.</li> <li>• <b>Long press:</b> Opens the [Select Mark] window.</li> </ul>
18	MENU/ESC	<ul style="list-style-type: none"> <li>• <b>Short press:</b> Opens or closes the menu. Goes back one layer in the menu.</li> <li>• <b>Long press:</b> Closes the menu.</li> </ul>
19	Trackball	<ul style="list-style-type: none"> <li>• Moves the cross-hair cursor.</li> <li>• Selects the menu item.</li> </ul>
20	Left button	<ul style="list-style-type: none"> <li>• <b>Short press:</b> Confirms the selection. Enters a fish mark 1 (factory default settings)*. Can be used for drag and drop operation.</li> <li>• <b>Long press:</b> Moves the own ship mark to the cross-hair cursor position.</li> </ul>
21	Right button	<ul style="list-style-type: none"> <li>• <b>Short press:</b> Opens the menu. Goes back one layer in the menu while operating the wheel knob. Stops the buzzer. Enters a event mark 1 (factory default settings)*.</li> <li>• <b>Long press:</b> Moves the own ship mark back to the center of the display.</li> </ul>
22	Speaker	<p>Outputs audio and buzzer for key operation.</p> <p><b>Note:</b> A thin waterproofing sheet is attached to the speaker on the control unit. Do not insert brushes or other objects into the speaker holes when cleaning them. If the sheet is torn, the speaker may be damaged if water leaks through the holes.</p>

\*: The entry function of the following marks can be assigned to the left and right buttons operations. If you wish to change the default factory settings, contact your dealer.

- Fish mark 1 or 2, Event mark 1 or 2, and Estimate mark 1 or 2.

### **Proximity sensor**

The control unit is equipped with a proximity sensor that prevents malfunction caused by vibrations. When the sensor recognizes and detects the movement of hand or fingers, the trackball is activated to operate. If there is no response in the sensor, change the position of your hand or fingers.

**Note:** The proximity sensor may shorten the detection distance for dark colors such as black and blue (brighter colors increase the sensing distance). Keep these colors in mind when operating the equipment.

### 1.1.2 Remote controller FSV-854-MK2 (Option)

The optional remote controller (connected to the processor unit) allows you to remotely operate the following functions.

**Note 1:** Do not leave the remote controller where it can be exposed to water or water splashes. When the remote controller is not in use, always hang it on the designated location.

**Note 2:** The functions assigned to each key can be changed (see section 6.4).

No.	Function (default settings)
1	Sets the tilt angle from the sea surface. <ul style="list-style-type: none"> <li>▲: Same operation as pressing the <b>TILT</b> lever upward on the control unit.</li> <li>▼: Same operation as pressing the <b>TILT</b> lever downward on the control unit.</li> </ul>
2	Adjusts the range. <ul style="list-style-type: none"> <li>▲: Same operation as turning the <b>RANGE</b> control clockwise on the control unit.</li> <li>▼: Same operation as turning the <b>RANGE</b> control counterclockwise on the control unit.</li> </ul>
3	Adjusts the gain. <ul style="list-style-type: none"> <li>▲: Same operation as turning the <b>GAIN</b> control clockwise on the control unit.</li> <li>▼: Same operation as turning the <b>GAIN</b> control counterclockwise on the control unit.</li> </ul>

### 1.1.3 Remote controller SCU-001 (Option)

The optional remote controller also allows you to remotely operate the following functions. However, it is required to connect the remote controller to the processor unit via Bluetooth®.

**Note 1:** To use the remote controller, connection of a Bluetooth® adapter (local supply) to the processor unit is required, and the adapter and the processor unit need to be paired. See subsection 6.5.1.

**Note 2:** The functions assigned to the function keys (A to E) on the remote controller can be changed (see subsection 6.5.3.). Other keys have pre-assigned functions and cannot be changed.

## 1. OPERATIONAL OVERVIEW

No.	Function (default settings)
1	<ul style="list-style-type: none"> <li>• <b>Short press:</b> Confirms the operating status of the unit.</li> <li>• <b>Long press:</b> Turns on/off the power of the unit.</li> </ul>
2	Performs the function assigned to the function key <b>F1</b> .
3	Performs the function assigned to the function key <b>F2</b> .
4	Performs the function assigned to the function key <b>F3</b> .
5	Joystick <ul style="list-style-type: none"> <li>• <b>Stick operation:</b> Moves cross-hair cursor.</li> <li>• <b>Short/long press:</b> Same operation as pressing the left button on the control unit.</li> </ul>
6	Enters an event mark 1.
7	Enters an event mark 2.
8	Adjusts the gain. <ul style="list-style-type: none"> <li>• +: Same operation as turning the <b>GAIN</b> control clockwise on the control unit.</li> <li>• -: Same operation as turning the <b>GAIN</b> control counterclockwise on the control unit.</li> </ul>
9	Sets the tilt angle to the sea surface. <ul style="list-style-type: none"> <li>• ↑: Same operation as pressing the <b>TILT</b> lever upward on the control unit.</li> <li>• ↓: Same operation as pressing the <b>TILT</b> lever downward on the control unit.</li> </ul>
10	Adjusts the range. <ul style="list-style-type: none"> <li>• +: Same operation as turning the <b>RANGE</b> control clockwise on the control unit.</li> <li>• -: Same operation as turning the <b>RANGE</b> control counterclockwise on the control unit.</li> </ul>

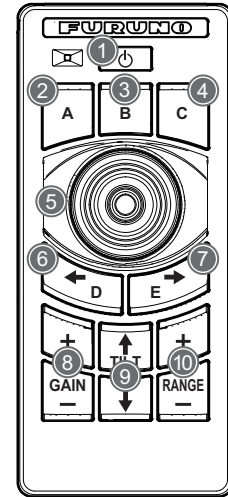

### 1.1.4 Small switch box SCU-003 (Option)

The optional small switch box (connected to the processor unit) allows you to remotely operate the following functions.

No.	Function
1	Turns on/off the power of the system.
2	Raises/retracts the transducer.
3	Not used.
4	Lowers/protrudes the transducer.

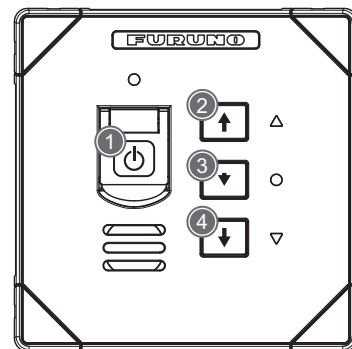

## 1.2 Basic Menu Operation

The CSH-10 has the following four menu options: User programmed-settings, sonar, sounder, and system. You can operate the menus by using the wheel knob or the trackball.

1. Press the **MENU/ESC** key to open the menu.

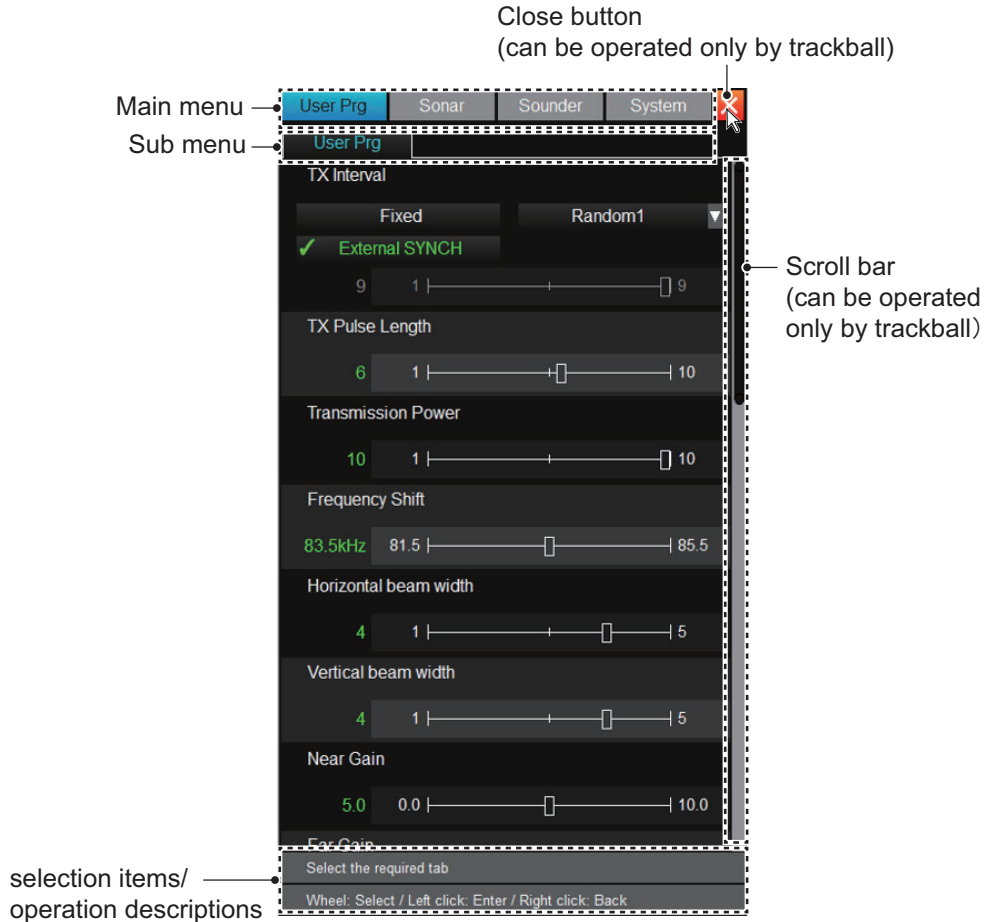

**Note 1:** The menu can also be displayed by right-clicking in the numeric/graphic display area (see section 5.1).

**Note 2:** While the menu is displayed, the software function keys (see section 1.6) are displayed at the bottom of the screen (however, function keys cannot be used). Only when [Record Still Images] is registered for [F1] to [F4], the function can be operated by pressing the corresponding key on the control panel.

2. Rotate the wheel knob or the trackball and select the desired menu from the main menu.
 

**For the wheel knob operation:** The color of the currently selected tab changes to light blue as the knob is rotated. The sub menu displays and menu items change according to the selected menu.

**For the trackball operation:** Moving the mouse cursor (  ) over the menu name does not change the color of the currently selected tab. Sub menu displays and menu items are changed by performing the confirmation operation in step 3.
3. Press the wheel knob or left button to confirm. If [Sonar] or [System] was selected in step 2, go to step 4. If [User Prg] or [Sounder] was selected, go to step 6.
4. Rotate the wheel knob or the trackball and select the desired tab from sub menu.
5. Press the wheel knob or left button to confirm.

## 1. OPERATIONAL OVERVIEW

6. Rotate the wheel knob or the trackball and select the menu item to adjust. The currently selected menu item turns light blue, and the menu item and its settings are enclosed with by a light-blue frame.

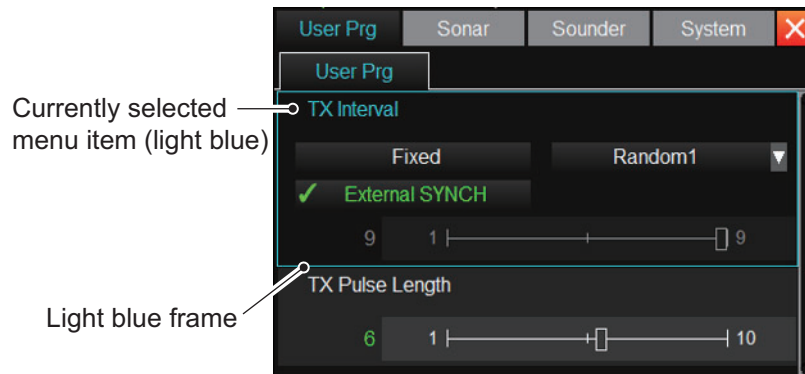

**Note 1:** If a menu item is grayed out, it indicates that the item is disabled.

**Note 2:** For trackball operation, you can click on the scroll bar or drag and drop the bar to display items that do not appear on the display.

7. Press the wheel knob or left button to confirm. The menu item selected in step 6 turns white and the settings can be adjusted.
8. Change the setting by either of the following methods. To cancel the operation, press the right button or the **MENU/ESC** key before confirming.

### Check mark

Current selection is marked with a check [✓] mark (green).

- 1) Rotate the wheel knob or the trackball to select the desired option. The currently selected option is enclosed with a light-blue frame.

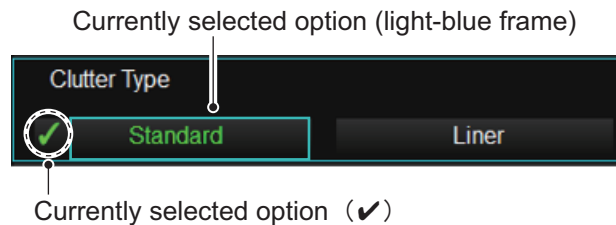

- 2) Press the wheel knob or left button to confirm. The option selected in 1) turns green and is marked with [✓].

### Slide bar

The value (green) shown at the far left end indicates the current setting.

- For wheel knob operation: Rotate the knob to change the setting value and press the wheel knob or the left button. While changing, the slider bar and the value displayed at the left end turn light-blue.

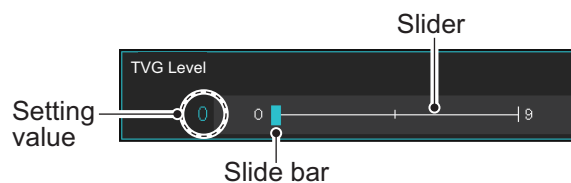

- For trackball operation: Click on the slider or drag and drop the slider bar to change the setting value. While dragging, the slider bar and the value displayed at the left end turn light-blue.



**Drop down list**

Current selection is shown in green.

- 1) Rotate the wheel knob or trackball to select the desired choice.  
The currently selected choice turns light-blue and is enclosed with a light-blue frame.

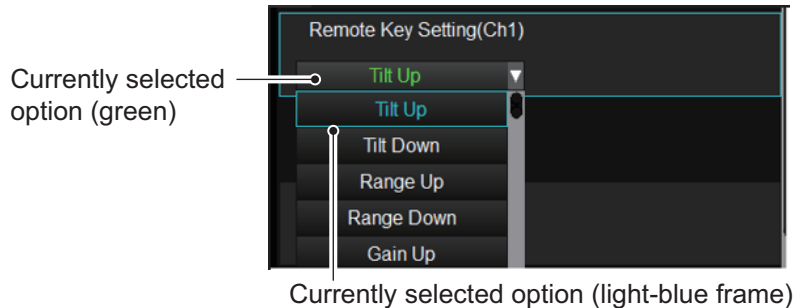

- 2) Press the wheel knob or left key to confirm.  
The option selected in 1) is shown in green.
9. Press and hold the **MENU/ESC** key to close the menu.  
For trackball operation, you can also click the [×] button to close the menu.
- Note 1:** You can change the display position of the menu to any desired location. Place the mouse cursor over an area other than where the sub menu tabs are and drag & drop to change. The next time you open the menu, the display position returns to the lower right corner of the screen.

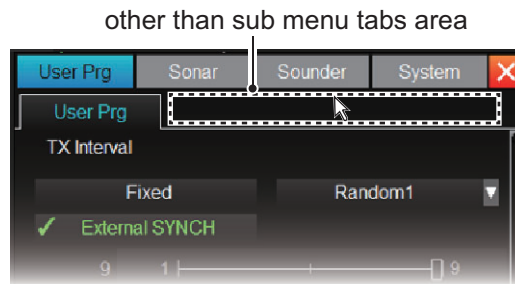

*For [User Prg] menu*

**Note 2:** Menu items in red are locked to prevent accidental setting changes. Selecting a red-colored item and pressing the wheel knob or left button displays the following confirmation message. To change the setting of the selected item, select "Yes" and press the wheel knob or the left button. The settings of the selected item can now be changed.

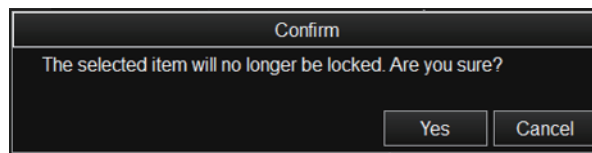

*Confirmation message*

## 1. OPERATIONAL OVERVIEW

### How to enter characters

When you select an item that requires text input, the software keyboard appears as shown below. The CSH-10 allows you to enter English alphabet (uppercase and lowercase characters), numbers, Japanese katakana, and symbols.



↑ ↓ Click [Shift] to switch

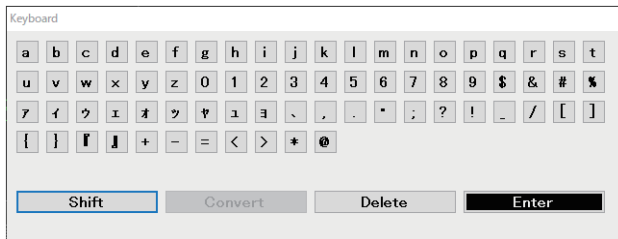

[Shift] : Change the characters and symbols.

[Convert] : Available in the future.

[Delete] : Erase selected character.

[Enter] : Confirm and finish.

1. Rotate the trackball to select the character and click. Repeat to select all desired characters. The wheel knob cannot be used for this operation.
2. Click [Enter] to finish.

## 1.3 Basic Operating Procedure

### 1.3.1 How to turn on the power



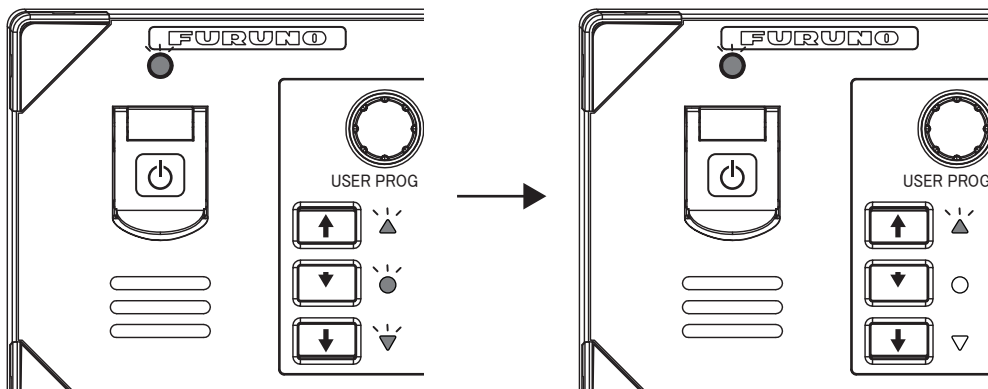

Open the power switch cover at the upper left of the control unit. Press the power switch key (⏻) to turn on the system. A beep sounds, and the display changes in the following sequence: FURUNO display→model display→operation test display (see section 10.10.2). Then the LED lamp on the left side changes as below. The last-used mode is activated in approximately 2 minutes and 20 seconds after turning on the power.



After the power is turned on  
(All lamps lighting)

Operation test completed  
(Power lamp and ↑ lighting only)

### 1.3.2 How to lower the transducer

To lower the transducer, reduce the ship speed to less than 18 kn, and press the  key. The lamp to the right of the  key flashes while lowering the transducer, and the message "Lowering " appears and flashes at the bottom of the display. After the transducer is fully lowered, the lamp to the right of the  key lights steadily. You can see the position of the transducer by the indicator at the top left corner on the display.

1

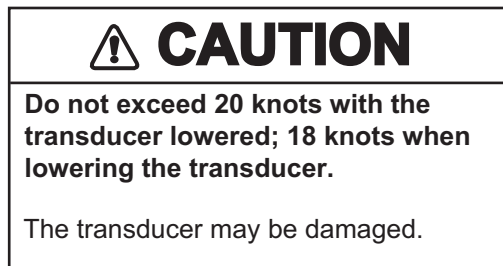

**Note:** In the following cases, the buzzer sounds at the same time as an alert or alarm occurs. The buzzer can be silenced by right-clicking.

- When the transducer is not fully protruded within 20 seconds. The message "<< SHIP SPD ALARM!! >>" appears.
- When the transducer is lowered without reducing the ship speed, or ship speed exceeds its allowable speed. The message "<< SHIP SPD ALARM!! >>" appears.

#### How to check the transducer position (TXR position indicator)

Use the TXR position indicator at the top left of the display to check the transducer position.

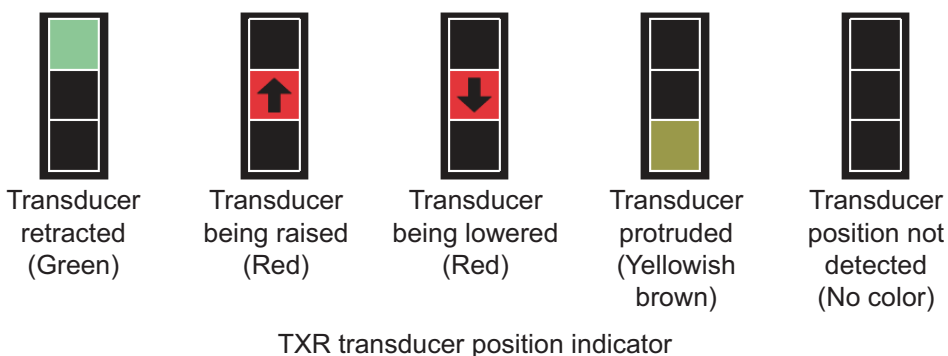

**Note:** When the transducer position cannot be detected, the entire TXR position indicator flashes.

### 1.3.3 How to start transmission

[Transmission] is set to [OFF] in the default condition. To start transmission, do the following operations. If it is set to [ON], transmission automatically starts as the transducer is lowered after turning on the power again. Transmission automatically stops when the transducer is completely retracted.

1. Open the menu.
2. Select the [System] tab from the main menu.
3. Select the [Test] tab from the sub menu.
4. Select [Transmission].
5. Select [ON]. The message "TX Start" appears, and the underwater images appear.
6. Close the menu.

**Note 1:** To stop transmission, select [OFF] in step 5 above. "TX Off" is displayed at the bottom of the display.

**Note 2:** In the factory default condition, click the software function key **F10** several times to turn transmission [ON] or [OFF].

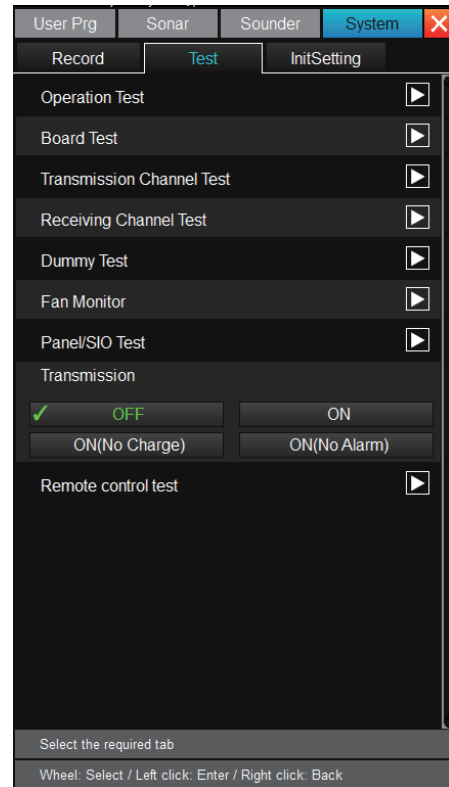

### 1.3.4 How to adjust the back lighting of the control panel

The brilliance can be adjusted from the [InitSetting] menu.

1. Open the menu.
2. Select the [System] tab from the main menu.
3. Select [InitSetting] tab from the sub menu.
4. Select [Dimmer].
5. Adjust the brilliance from 0 to 15.
6. Close the menu.

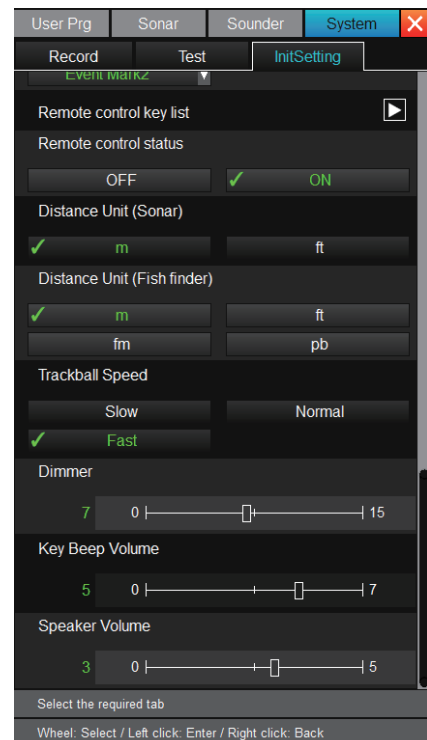

### 1.3.5 How to select the display mode

There are two types of display mode available on this equipment. The mode can be switched on the [Sonar] menu.

Display mode	Description	Display
[H]	The 360° sonar echo image of own ship is displayed on the echo picture display area* of the horizontal single display. Numeric and graphic are displayed on the right side. See section 5.1.	
[H & FF]	The fish finder area is also displayed. See chapter 4 for details. <b>Note:</b> A fish finder is required to show the fish finder displayed.	

\*: The echo display is set to [Within Range] at the factory. Contact your dealer to change the settings.

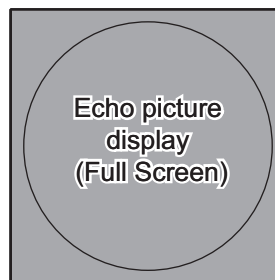
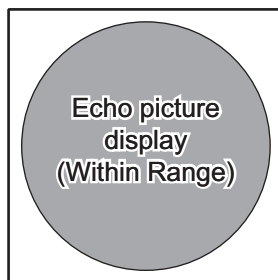

# 1. OPERATIONAL OVERVIEW

1. Open the menu.
2. Select the [Sonar] tab from the main menu.
3. Select the [Sonar] tab from the sub menu.
4. Select [Display Mode].
5. Select one of the display modes.
6. Close the menu.

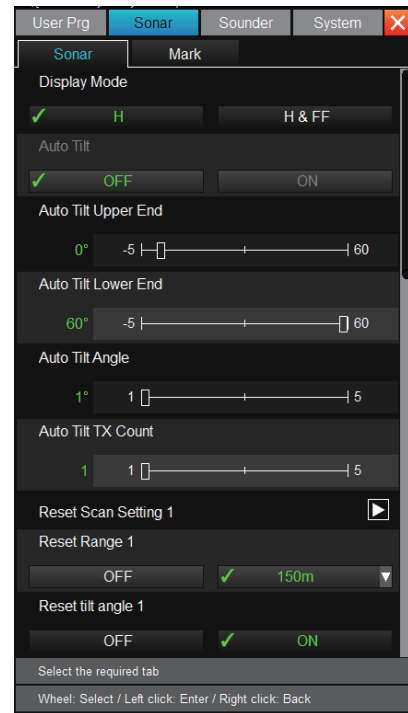

## Sonar display example

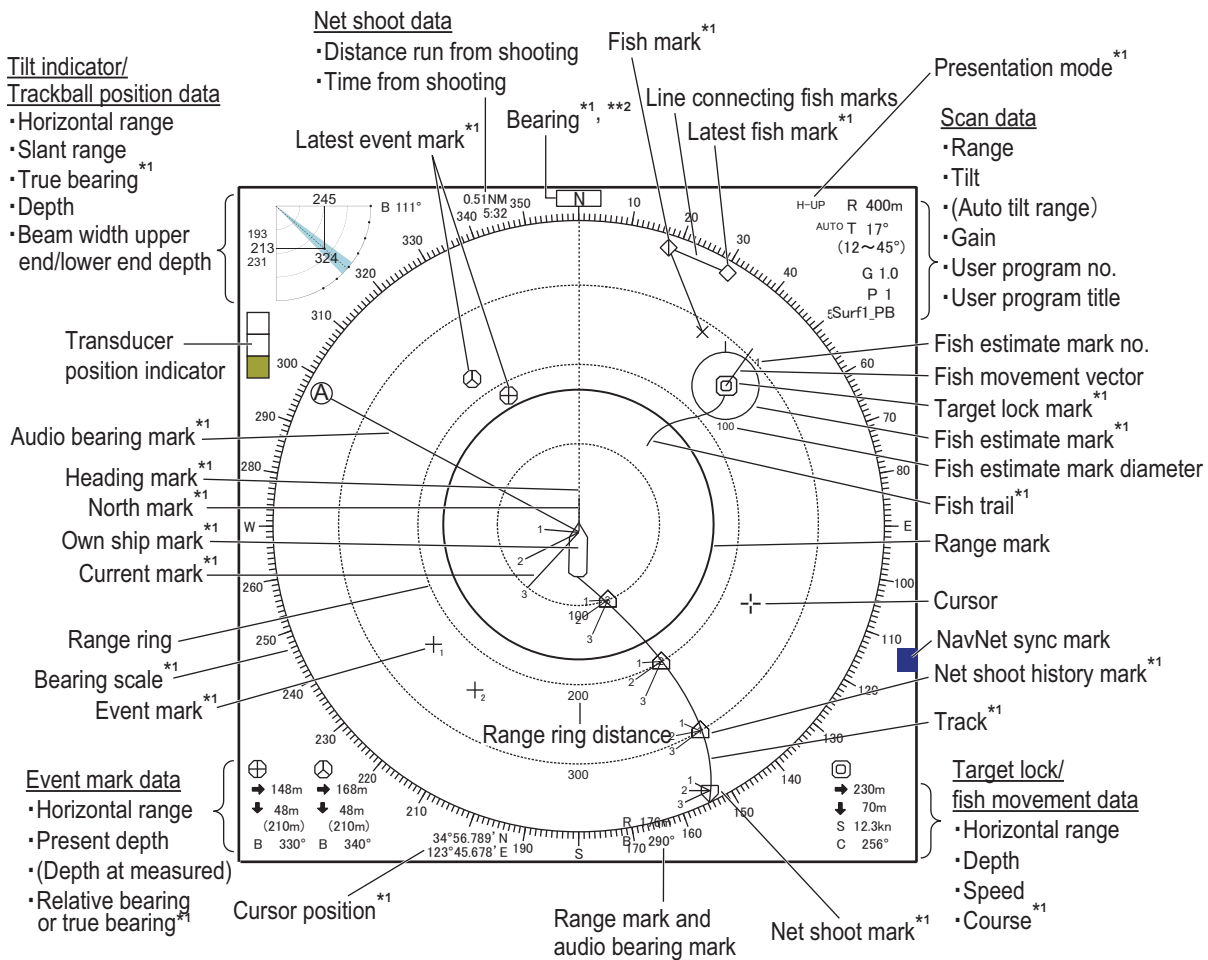

\*1: This function requires appropriate data input; see "DATA INPUT REQUIREMENTS" on page AP-8.

\*2: Shown only in head-up mode.

**Note:** To change the color of Event Marks, Fish Marks and Estimate Marks, contact your local dealer.

**Presentation mode**

This sonar has three presentation modes, head-up, north-up, and course-up. For the factory default, the orientation mode is set to [head-up] (only a technician can change the setting).

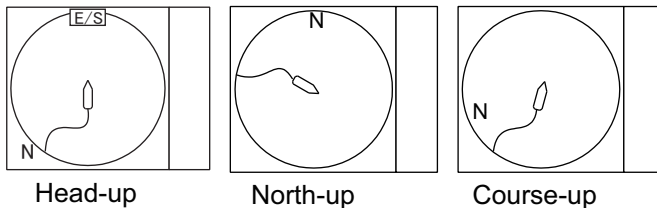

Presentation modes require appropriate data input. For details, see "DATA INPUT REQUIREMENTS" on page AP-8.

**Head-up:** The display is oriented toward ship's heading. The heading direction appears at the top of the display. Own ship position is fixed at the screen center. Echoes from fish and the bottom move on the screen relative to own ship's movement. This mode is useful for general use.

**North-up:** The display is oriented so North is at the top of the screen. Own ship position is fixed at the screen center and own ship mark pivots with ship's movement. Echoes from fish and the bottom move on the screen relative to own ship's movement.

**Course-up:** The display is oriented according to course. Own ship position is fixed at the screen center. Echoes from fish and the bottom move on the screen relative to own ship's movement. Targets are displayed at ship's bow.

**About track**

The own ship track is shown with a solid line when necessary data is input (see page AP-8). When the capacity of the track memory is exceeded, the earliest track is automatically erased to trace new track. Water temperature and depth can be indicated on the track. Consult with a FURUNO technician for how to display the data.

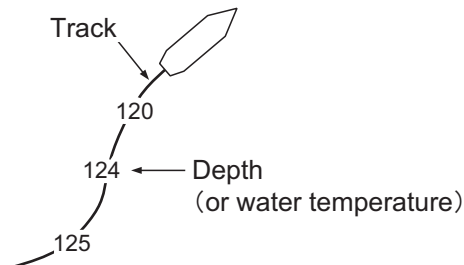

**NavNet sync mark**

When [Navnet Synchronization] is turned ON in the [Input (external)] menu of the [Installation Setting] menu, the NavNet sync mark appears on the right edge of the sonar display to indicate that the CSH-10 is synchronized with a NavNet TZtouchXL unit. (The setting can only be changed by a service technician.) When the mark is displayed, the CSH-10 can be operated (certain functions only) from a NavNet TZtouchXL unit connected to the LAN2 port on the Processor Unit.

The NavNet TZtouchXL program version that supports the NavNet sync function is 1950248-25.11 or later.

For further information, see the NavNet TZtouchXL Operator's Manual.

NavNet sync mark

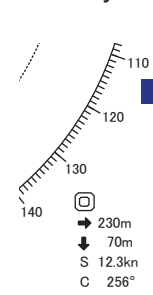

### 1.3.6 How to select the detecting range

The detecting range can be selected according to the school of fish or the distance to the bottom.

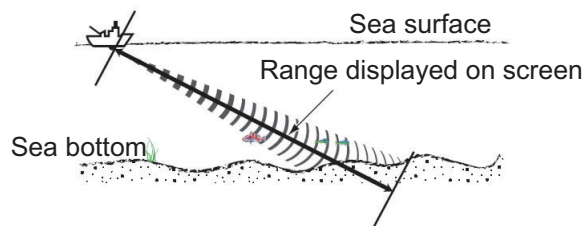

The **RANGE** control changes the detecting range. The default ranges (in meters) are 50, 60, 70, 85, 100, 125, 150, 200, 250, 300, 350, 400, 500, and 600. Turn the control clockwise to increase the range, or counter-clockwise to decrease the range. Each time the range is changed, the newly selected range appears in large characters for five seconds. The current range is always displayed at the top right corner of the sonar display, next to the [R] text.

**Note 1:** The ranges selected with the **RANGE** control can be changed. Contact your dealer for details.

**Note 2:** The range can also be adjusted directly from the range indication. Place the cursor over the range indication to highlight it in light-blue, and then turn the wheel knob to confirm the range.

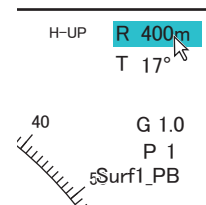

**Note 3:** By default, the range is automatically changed when target lock is active, and cannot be changed by the operator. To enable range adjustment in target lock, consult with a FURUNO dealer.

### 1.3.7 How to adjust the gain

The **GAIN** control adjusts receiver sensitivity. Adjust the gain to see fish echoes clearly with minimal noise on the display. If the gain is too high, it causes excessive noise on the display, and makes it difficult to discriminate wanted fish echoes from bottom echoes. A setting between 3 and 7 is usually suitable.

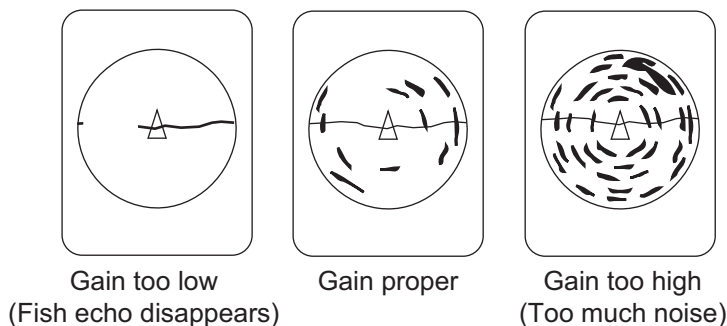



Turn the **GAIN** control to adjust the gain (setting range:0.0 to 10.0). Turn the control clockwise to increase the gain, or counter-clockwise to decrease the gain. Each time the control is operated, the newly selected gain appears in large characters for five seconds at the top of the sonar display. The current gain is always displayed at the top right corner of the sonar display, next to [G] text.

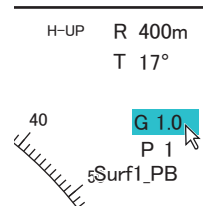

**Note:** The gain can also be adjusted directly from the gain indication. Place the cursor over the gain indication to highlight it in light blue, and then turn the wheel knob to confirm the gain.





### 1.3.8 How to raise the transducer, turn off the power

1. After completing operation, reduce the ship speed less than 18 knots, and then press the  key. The LED lamp to the right of the  key flashes while raising the transducer, and the message "Raising  key lights, and the message "Retracted" appears on the display.

**Note 1:** If you try to raise the transducer without reducing the ship's speed below 18 knots, the alert message "<< SHIP SPD ALARM!! >>" appears, and the buzzer sounds. The buzzer can be silenced by the right-click.

**Note 2:** For your safety, always retract the transducer before turning the power off. If the power of the equipment is turned off when the transducer is protruded, the transducer will automatically be raised and retracted.

**Note 3:** If the transducer cannot be completely retracted within 20 seconds, the alert message "<< TRANSDUCER NOT RETRACTED!! >>" appears, and the buzzer sounds. See section 10.11 for how to manually retract the transducer.

2. After the LED lamp to the right of the  key is lit, press the  key.
 

**Note:** The sonar is equipped with a function to automatically retract the transducer once the ship exceeds the operator-set speed (see page 9-5). When the automatic retract function is [ON], the transducer may be retracted at a different speed other than the set speed if the speed data acquired from the external device is different from the actual speed. In all cases, always reduce the ship speed to less than 18 knots before/while raising and retracting the transducer even if the automatic retract function is [ON].

## 1.4 Tilt Angle

The tilt angle shows the angle from the sea surface at which the sound wave is emitted. When the sound wave is emitted horizontally, it is said to be zero (0) degrees, and when emitted vertically, 90 degrees.

### 1.4.1 How to set the tilt angle

To manually set the tilt angle, operate the **TILT** lever. The tilt angle can be set in 1° increments, from -5° (upward from horizontal plane) to 60° (downward from horizontal plane). The tilt angle decreases when the lever is tilted upward, and increases when the lever is tilted downward. Each time the angle is changed, the newly set angle appears in large characters for five seconds. The current angle is always displayed at the top right corner, next to the [T] text. Set the tilt angle suitable for your target fish, a shallow angle (approx. 5°) for surface fish, and a deeper angle for bottom fish. In addition, the tilt indicator in the upper left corner of the screen allows the user to keep track of the detection angle.

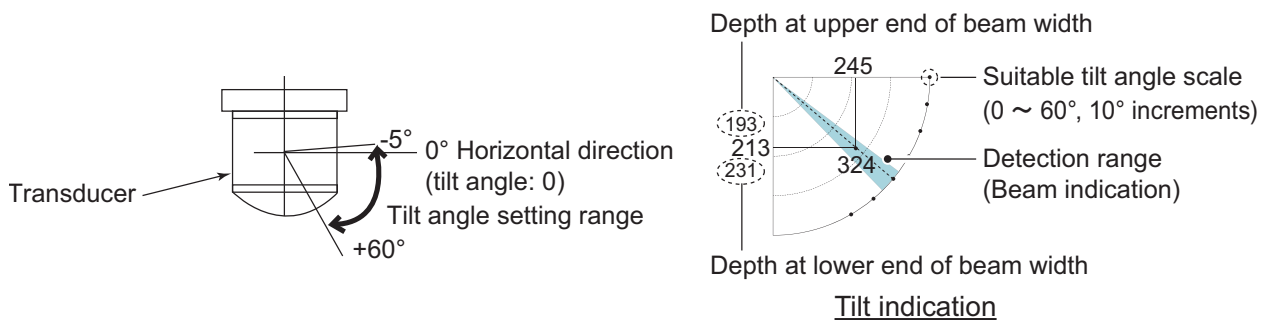

**Note 1:** By default, the tilt angle can be set using the wheel knob.

**Note 2:** The tilt angle can also be adjusted directly from the tilt angle indication. Place the cursor over the tilt angle indication to highlight it in light blue, and then turn the wheel knob to confirm the tilt angle.

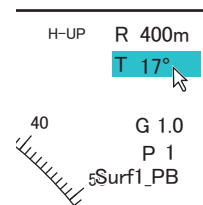

### 1.4.2 How to turn automatic tilt on/off

The automatic tilt function automatically tilts the transducer within the tilt range selected on the menu. This function is useful for finding center of a school of fish.

**Note:** This function is disabled while the target lock is active, or the transducer is being retracted.

1. Transmit, then open the menu.
2. Select the [Sonar] tab from the main menu.
3. Select the [Sonar] tab from the sub menu.
4. Select [Auto Tilt].
5. Select [ON]. The new settings appear in large characters for five seconds.
6. Set the automatic tilt range (ranges within upper and lower ends).
  - 1) Select [Auto Tilt Upper End].
  - 2) Set the upper angle from -5° to 60°.

- 3) Select [Auto Tilt Lower End].
- 4) Set the lower angle from -5° to 60°.
7. Adjust the automatic tilt settings if necessary as follows.
  - 1) Select [Auto Tilt Angle].
  - 2) See the following table and set the auto tilt angle from 1° to 5°.
  - 3) Select [Auto Tilt TX Count].
  - 4) See the following table and set the TX count from 1 to 5.

	[Auto Tilt Angle]	[Auto Tilt TX Count]
If you want to search the auto tilt range in detail	Decrease the value	Increase the value
If you want to search for fast swimming fish	Increase the value	Decrease the value

8. Close the menu.  
 The automatic tilt function is enabled within the set range. When the auto tile function is active, [AUTO] is displayed next to the tilt angle indication. Also, the beam inside the tilt indication works in conjunction with the auto tilt.

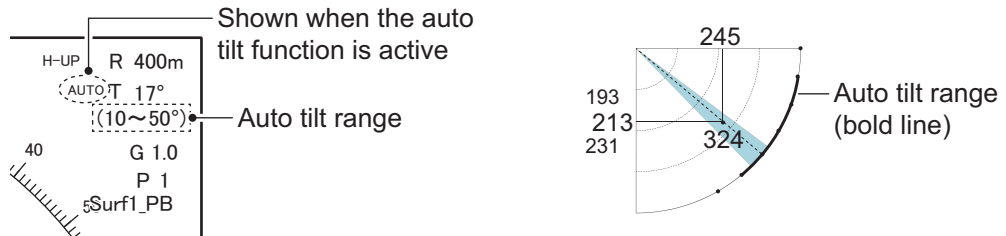

For example, when set as below, the auto tilt angle changes as follows.

- [Auto Tilt Upper End]: 15°
- [Auto Tilt Lower End]: 35°
- [Auto Tilt Angle]: 2°
- [Auto Tilt TX Count]: 2

25° → 25° → 27° → 27° → ... 33° → 33° → 35° → 35° → 33° → 33° ... → 17° → 17° → 15° → 15° → 17° → 17° ...

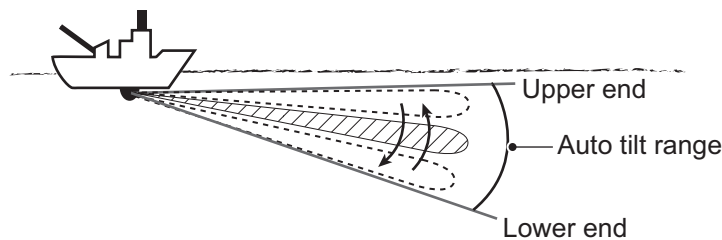

**Note 1:** To disable the auto tilt function, select [OFF] in step 5 above.

**Note 2:** The auto tilt range can also be adjusted directly from the tilt range indication. Place the cursor over the tilt range indication to highlight it in light blue, and then turn the wheel knob to set the tilt range.

**Note 3:** This function is disabled when the target lock function is turned on. The auto tilt is resumed from the mean value of the auto tilt range once the target lock is disabled.

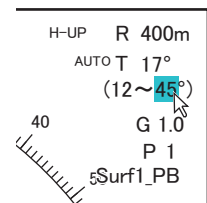

### 1.4.3 How to distinguish fish echoes from the bottom

Finding the proper tilt angle is of utmost importance when searching for fish, especially in coastal water fishing, where the depth of the fishing ground is from 50 to 100 m. In this type of fishing ground, it is imperative that the bottom echo be always displayed to properly distinguish between fish and the bottom. When selecting a tilt angle, keep the following points in mind.

#### **Case 1: Tilt angle 30 to 40°**

This tilt angle uses the full beam width to receive echoes, thus the entire bottom echo is displayed. Fish echoes may be hidden in the bottom echo.

#### **Case 2: Tilt angle 10 to 20°**

This tilt angle receives bottom echoes within the bottom half of the beam. Fish echoes astern of the bottom echo are displayed.

#### **Case 3: Tilt angle 0 to 5°**

This tilt angle may or may not display returning echoes. Fish echoes near the bottom echo are displayed.

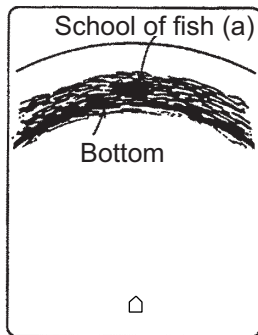
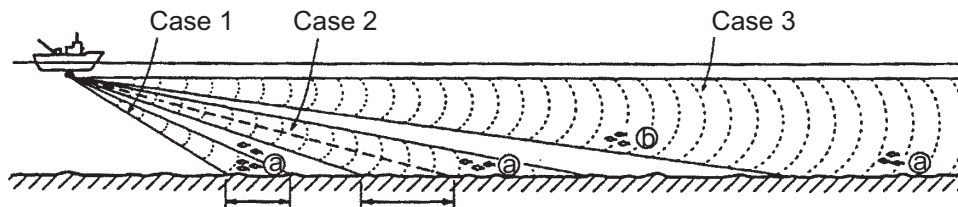

Case 1

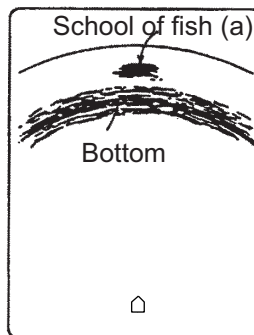

Case 2

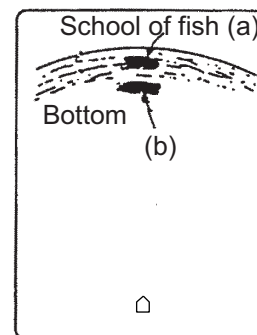

Case 3

To distinguish the bottom and schools of fish, keep the following points in mind.

- In general, a vertically distributed school of fish is a better sonar target than a horizontally one, since it reflects the transmitted pulse back towards to the source.
- In case 3, both schools of fish (a) and (b) are presented. In general, midwater schools of fish tend to be larger than bottom schools of fish, and they are often displayed near the bottom on the sonar display.
- When the bottom schools of fish are displayed horizontally, it is difficult to detect fish echoes.

### 1.4.4 Tilt angle for surface fish

An ultrasonic wave emitted from the sonar transducer forms an oval-shaped beam with a width of approximately 6° in the vertical direction (vertical beam width at -3 dB). The tilt angle indicates the angle between the centerline of the beam and the horizontal plane. Then, if the tilt angle is set to 0°, the centerline is parallel with the sea surface and one half of the emitted sound goes upward, toward the sea surface.

This causes the emitted ultrasonic wave to be reflected toward the transducer, and shown on the display as sea surface reflections. When the sea is calm, since the sound is reflected just like a light hitting a mirror at a low incident angle, it propagates away and the sea surface reflections become negligible.

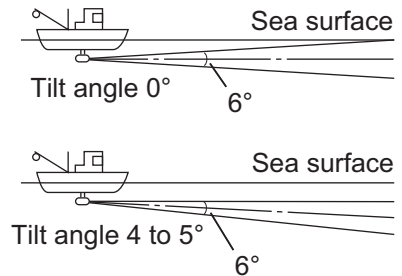

However, if the sea is rough, they become dominant and interfere with observation of wanted echoes. To minimize these sea surface reflections, and to search for schools of fish on the surface effectively, set the tilt angle between 4° and 5°, so the upper portion of the beam becomes almost parallel with the sea surface. If noise still appears, slightly increase the tilt angle to lessen the affect of the sea surface reflections.

### 1.4.5 Suitable tilt angle

The figure below illustrates the relationship among tilt angle (0°, 5°, 10°, 15°), depth and detection range. Refer to it to find out the suitable tilt angle for a given depth or detection range.

Tilt angle setting: relationship between tilt angle and detection range

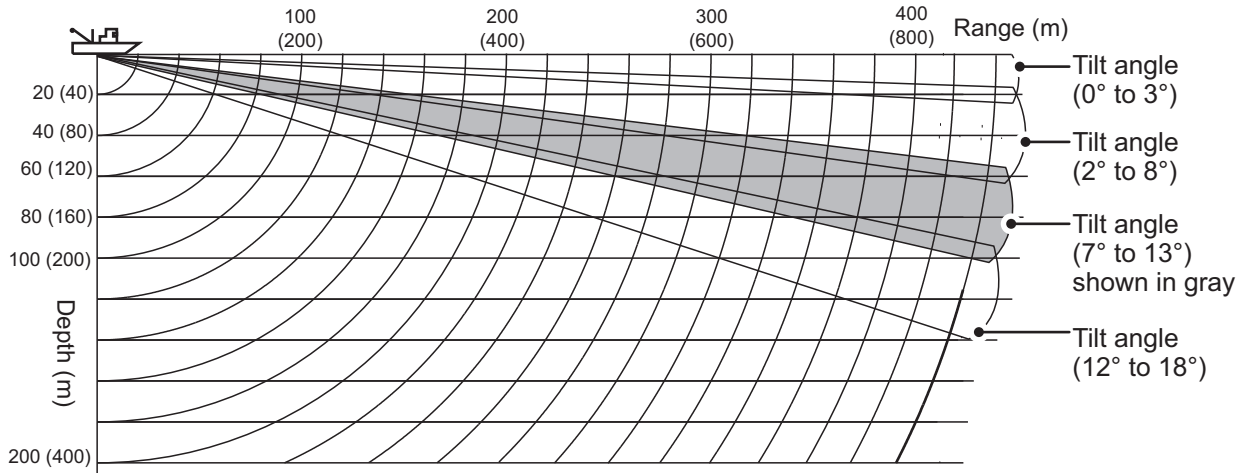

Vertical width of sonar beam

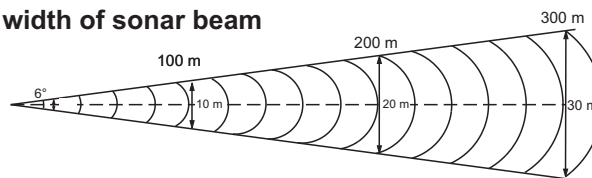

## 1.5 Range and Bearing to a Target

Operate the trackball to place the cross-hair cursor (trackball mark) on the target you want to measure the range and bearing. The range from the own ship position, bearing, and depth to the target appear at the upper left corner of the sonar display. The latitude and longitude of the cross-hair cursor position are also displayed on the bottom of the display.

**Note:** Input from an external device is required to display the latitude and longitude of the cross-hair cursor position (see page AP-7).

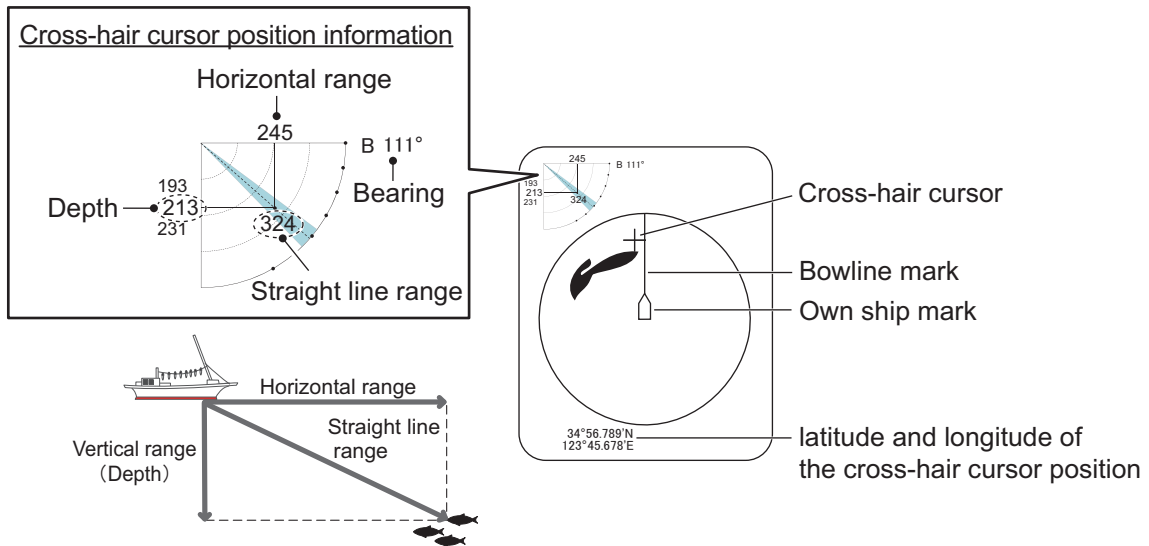

## 1.6 Software Function Keys

The software function keys provide shortcuts to frequently used functions. You can see the current settings for each software function key. With all menus closed, place the cross-hair cursor at the bottom of the display for approximately two seconds to show the software function keys. The functions assigned to F1 to F4 can be used with a single press of the key. For how to register functions to the software function keys, see subsection 6.1.2.

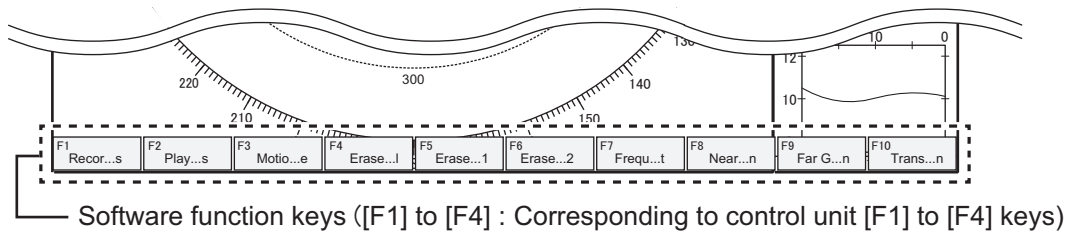

# 2. FINE TUNING THE SONAR PICTURE

## 2.1 How to Eliminate Unwanted Echoes

Echoes from targets such as the bottom and fish return to the transducer in order of the distance to them, and when we compare their intensities at the transducer face, those from nearer targets are generally stronger when their reflecting properties are nearly equal. The sonar operator will be quite inconvenienced if these echoes are directly shown on the display, since the actual size of the target cannot be judged from the size of echoes displayed.

The proper gain in an area within 300 m (factory default setting at [P1] under [User Prg]) to suppress unwanted echoes and noise can be set for both [Near Gain] and [Far Gain]. To obtain the proper gain setting, follow the procedure below.

1. Open the menu.
2. Select the [User Prg] tab from the main menu.
3. Select [Near Gain] or [Far Gain].
4. Adjust the gain (setting range: 0.0 to 10.0). Unwanted echoes cannot be eliminated with the setting value of 5.0. Use a setting under 5.0 to reduce the gain; greater than 5.0 to increase the gain.
5. Close the menu.

**Note:** In the factory default setting, press the software function key **F8** (Near Gain) and **F9** (Far Gain) alternately to toggle the gain settings.

- When a school of fish is detected at a long distance (approx. 800 m), and if the school is gradually approaching your ship, do the following operations:
  - 1) Adjust the tilt angle so that the school is placed in the center of the sonar beam, and is displayed in the strongest colors.
  - 2) Check that the fish echo is displayed in the same color while it is approaching your ship.
  - 3) If the color changes suddenly to weaker colors as the fish echo enters far or near areas, increase the [Near Gain] settings.

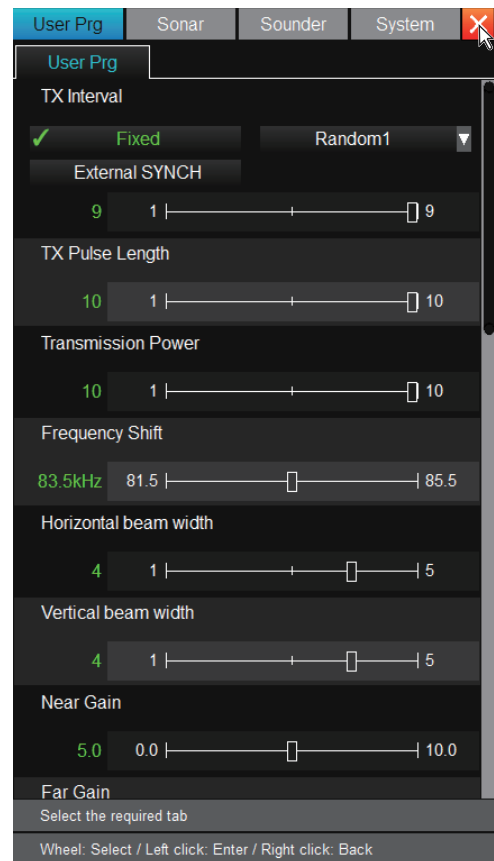

## 2.2 How to Suppress Bottom Tail

As noted earlier, schools of fish (echoes) located near the bottom are sometimes difficult to detect because you have to discriminate them from the bottom reflections. With [AGC Near], [AGC Far], or [TX Pulse Length] (in the [User Prg] menu) used properly, the tail of bottom reflections is decreased, making it easier to discriminate bottom fish.

### 2.2.1 How to set AGC near/far

The AGC reduces the receiver gain only against strong echoes such as the bottom or a large school of fish. Since weak echoes remain unaffected, a small school of fish becomes easier to detect. Adjust the AGC properly so it works only on bottom reflections. Set in a area within 270 m (factory default setting with [P1] under the [User Prg]), with the [P2] to [P10] in a area within 200 m) for the [AGC Near], and [ACG Far]. Do not set the value too high, as weak echoes may disappear.

1. Open the menu.
2. Select the [User Prg] tab from the main menu.
3. Select [AGC Near] or [AGC Far].
4. Set AGC value properly (setting range: 0.0 to 10.0). The higher the setting, the greater the AGC effect. However, if the setting is too high, weak echoes may be erased.
5. Close the menu.

### 2.2.2 How to adjust the pulse length

The pulse length control determines the length of the transmission pulse emitted into the water. While a longer pulse is advantageous for long-range sounding, it has the disadvantage of being poor in discrimination of targets, i.e., ability to separate several closely located targets. When searching bottom fish, it is useful to shorten the pulse length in order to separate fish echoes from bottom reflections.

**Note:** To search the surface fish or midwater fish in which bottom reflections are not so strong, the longest pulse length [10] should be used.

1. Open the menu.
2. Select the [User Prg] tab from the main menu.
3. Select [Transmission Pulse].
4. Set the value (setting range: 1 to 10). The lower setting has the shorter pulse.
5. Close the menu.

### 2.2.3 How to suppress the unwanted echoes (noise suppression)

Removing or suppressing noise from weak echoes such as sea clutters, planktons, distant sea bottoms, or propeller noise\* can help you clear the display. The noise suppression function adjusts the gain level for weak echoes only, leaving schools of fish echoes unadjusted.

\*: Noise from other ships may be displayed as strong echoes in a distant detecting range depending on the setting level.

1. Open the menu.



2. Select the [User Prg] tab from the main menu.
3. Select one of the following settings.
  - [Noise Suppression]: Suppresses noise from weak echoes such as sea clutter, plankton, and distant sea bottom.
  - [Noise Suppression (SHIP)]: Suppresses propeller noise from other ships.
4. Adjust the value (setting range: 0.0 to 10.0). The higher the setting, the greater the degree of suppression. However, if the setting is too high, weak echoes may be erased.
5. Close the menu.

## 2.3 How to Suppress Bottom Echoes and Sea Clutters in Shallow Fishing Grounds

In shallow fishing grounds with hard or rocky bottom, bottom reflections often interfere with wanted fish echoes, and they can not be eliminated sufficiently with the aforementioned near gain and AGC, especially when the tilt angle is large in order to track schools of fish approaching within 400 m. In such cases, try to reduce the transmission power without turning down the gain. The picture becomes clearer when the transmission power output is reduced rather than when the gain is decreased as illustrated below.

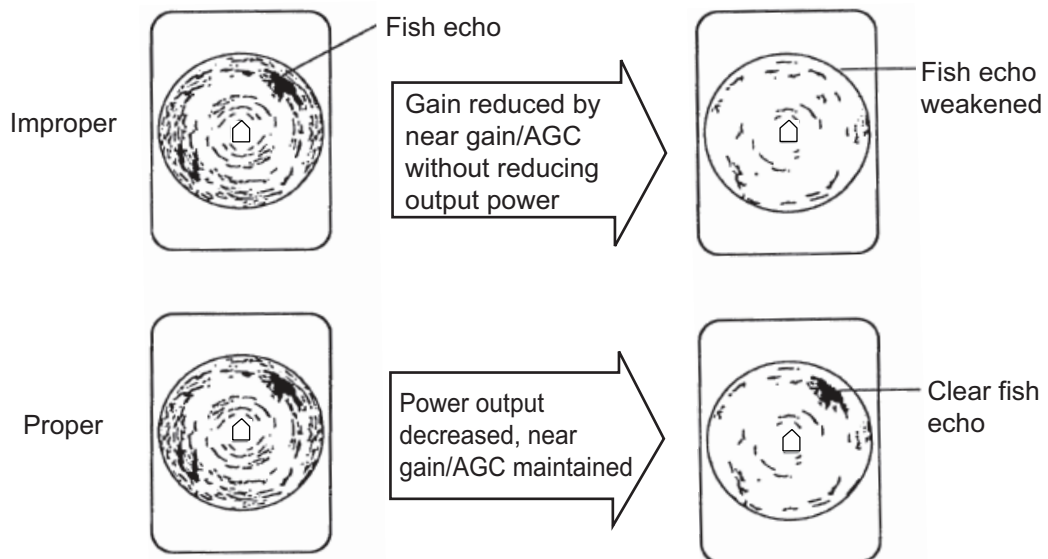

### *How to suppress bottom and sea clutters in shallow fishing grounds*

1. Open the menu.
2. Select the [User Prg] tab from the main menu.
3. Select [Transmission Power].
4. Adjust the value (setting range: 1 to 10). The higher the setting the greater the transmission power.
5. Close the menu.

**Note:** For long range detection, set to 10.

## 2.4 How to Reject Sonar Interference and Noise

While observing the sonar picture, you may encounter occasional (or periodical) noise and interference. These are mostly caused by on-board electronic equipment, engine, propeller noise, or electrical noise from other sonars being operated on other ships nearby.

### 2.4.1 How to identify noise source

To reject noise effectively, identify the noise source first.

1. Set [Transmission] to [OFF] from the [Test] menu to stop transmission (see section 10.10.1), and turn on the power of all onboard equipment one by one while observing the picture. If any noise is observed when a device is turned on, that means the equipment is a noise source. Check for cable connections including grounding.

**Note:** In the default arrangement, transmission can be turned on or off with the software function key **F10**.

2. Run the ship at various speeds to check if the noise is speed dependent.

If neither of the above two steps affects on the picture, see the sections below.

### 2.4.2 How to reject noise with the interference rejector

This control is effective for rejecting random noise, sea clutter in rough sea conditions, and noise from other sounders. Set the interference rejector properly so that only noise is eliminated. Do not use an unnecessarily high setting since small wanted echoes may also be rejected.

1. Open the menu.
2. Select the [User Prg] tab from the main menu.
3. Select one of the following settings.
  - [Interference Rejector 1]: Rejects random noise and sea clutter in rough sea conditions.
  - [Interference Rejector 2]: Rejects noise from other sounders such as a fish finder.
4. Set the interference rejection level.
  - [Interference Rejector 1]: Select [Weak] or [Strong]. [OFF] turns off the interference rejector.
  - [Interference Rejector 2]: Set the value from 0 to 6. The higher the setting, the greater the degree of interference rejection. 0 turns off the interference rejector.
5. Close the menu.

### 2.4.3 How to reject noise with the noise limiter

Weak, unwanted echoes, colored light blue or green, are displayed when water is murky, plankton layers exist, or there is ship's noise. These types of noise can be rejected with the noise limiter. With a higher setting the color of the unwanted echoes are painted in the background color. Normally, the setting of 3 or 4 is suitable to reject this type of noise.

1. Open the menu.

2. Select the [User Prg] tab from the main menu.
3. Select [Noise Limiter].
4. Adjust the setting value (setting range: 0 to 10). The higher the setting, the greater the noise limiter effect.
5. Close the menu.

#### 2.4.4 How to reject interference with transmission interval

When other ships with a sonar of the same transmission frequency as own sonar are near, "rings" of interference may appear. To reject this interference, adjust the transmission interval setting as follows.

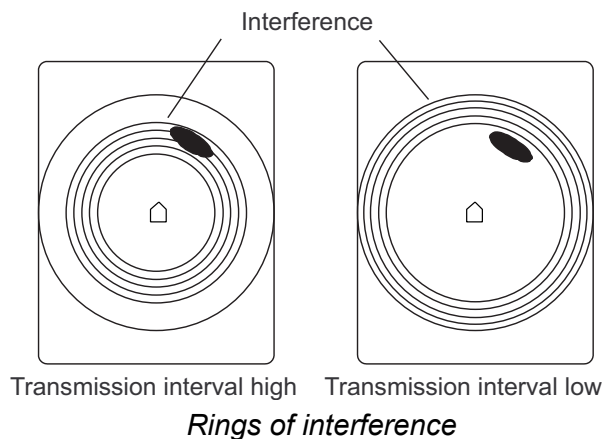

1. Open the menu.
2. Select the [User Prg] tab from the main menu.
3. Select [TX interval].
4. Select one of the following transmission intervals.
  - [Fixed]: Sets the transmission interval (setting range: 1 to 9). The lower the setting, the longer the transmission interval.
  - [Random 1] to [Random 4]: Changes the cycle for each transmission. This prevents interference from being received at the same time. The larger the value, the greater the degree of change in the transmission cycle.
  - [External SYNCH]: Synchronizes the intervals with the signal input from an external source.
5. Close the menu.

#### 2.4.5 How to shift the transmission frequency

If the interference can not be suppressed by the interference rejector, or change in transmission interval, shift the transmission frequency as shown below.

1. Open the menu.
2. Select the [User Prg] tab from the main menu.
3. Select [Frequency Shift].
4. Adjust the value (setting range: 81.5 kHz to 85.5 kHz).
5. Close the menu.

**Note:** In the default arrangement, you can use the software function key **F7** (frequency shift) can be used to cycle through the frequency settings.

### 2.4.6 How to use echo average

The echo average function adjusts echo afterglow - the amount of time an echo signal remains on the display. This feature can be useful for watching echo movement. Adjust the setting so that targets are clearly visible on the display.

1. Open the menu.
2. Select the [User Prg] tab from the main menu.
3. Select [Echo Average].
4. Adjust the value (setting range: 0 to 11).
  - Setting range 1 to 7: Echoes are gradually displayed and afterglow remains on the display longer as the setting is increased. This setting range is effective for removing the unwanted echoes that randomly appear on the display such as sea clutter.
  - Setting range 8 to 11: Echoes appear quickly, and the higher the value, the longer the afterglow remains on the screen. Adjust the setting so that the targeted fish are easy to see.
5. Close the menu.

## 2.5 How to Choose Beamwidth

Unwanted echoes can be suppressed by adjusting the width of the horizontal beam and vertical beam.

1. Open the menu.
2. Select the [User Prg] tab from the main menu.
3. Select [Horizontal beam width] or [Vertical beam width].
4. Adjust the value (setting range: 1 to 5).
  - [Horizontal beam width]: The higher setting narrows the horizontal beamwidth. This is useful to discriminate weak echoes.
  - [Vertical beam width]: The higher setting narrows the vertical beamwidth. This is useful to discriminate fish echoes near the sea bottom.
5. Close the menu.

## 2.6 How to Remove Weak Echoes

You can remove weak echoes according to strength to clear the picture. This feature is useful to observe only large schools of fish or to suppress interference.

1. Open the menu.
2. Select the [User Prg] tab from the main menu.
3. Select [Signal Level].
4. Adjust the value (setting range: 0 to 31). With the higher setting, the weaker echoes are removed first.
5. Close the menu.

# 3. ADVANCED SONAR OPERATION

## 3.1 How to Track a School of Fish (Target Lock)

The target lock function automatically tracks a school of fish so you will not lose sight of it on the display. Two types of target lock modes are available: position tracking (Target Mark) and tracking of school of fish (Fish). Tracking a school of fish (Fish) is set as default. To use this function, external data input is required (see page AP-7). If the echo from a school of fish is too weak the school cannot be tracked.

Only one target lock can be active at any time.

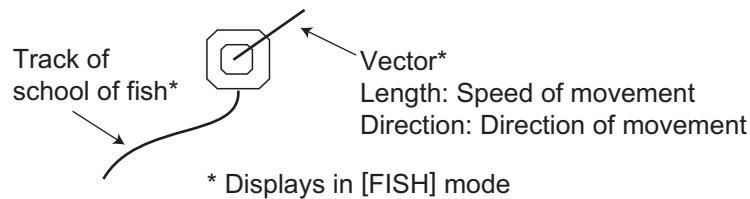

Target lock mark

**Note:** To change the target lock mode, contact your point of purchase, or our nearest branch/sales office.

### 3.1.1 Fish mode

The fish mode automatically tracks the operator-selected school of fish. Even if the tracked school of fish goes out of the zone in the range direction, the range and tilt are automatically controlled according to the position of the school of fish (only service technicians can change the settings).

1. With the trackball, place a cross-hair cursor on the school of fish to track.
2. Press the **TARGET LOCK** key.

The target lock mark (⊞) is displayed on the school of fish echo. The color of the target lock mark (with vector) changes to white when the school of fish is captured by the target lock. The vector shows the speed and direction of movement of the school of fish. The tip of the vector is the estimated position of the school of fish when the

certain time elapses. The target lock data is shown at the bottom right of the display. In the default arrangement, the estimate mark 1 (surrounds the target lock mark) is also shown. See section 3.7 for details.

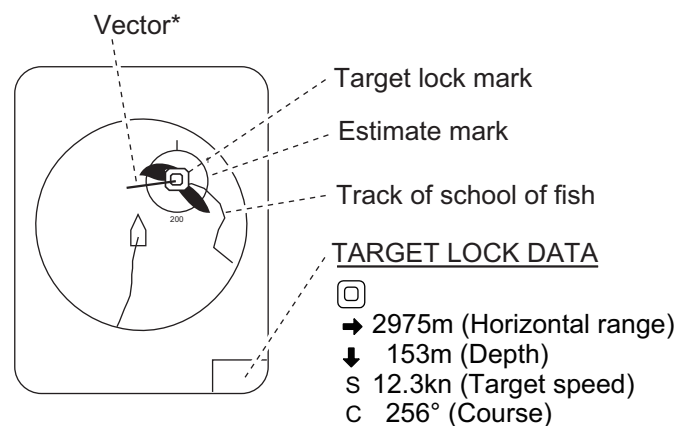

\*: A bearing sensor is required.

### 3. ADVANCED SONAR OPERATION

**Note:** If the vector or track is not shown on the display, contact your dealer.

If the target is lost, the target lock mark color changes from white to red, and the tracking mode changes to position mode (Target Mark) at that position. When the sonar detects and tracks the target again, the tracking mode (Fish) is restored.

3. To disable the target lock, press the **TARGET LOCK** key.

#### 3.1.2 Target mark mode

The target mark mode tracks fixed positions (reef. etc.) using position data fed from a position fixing device.

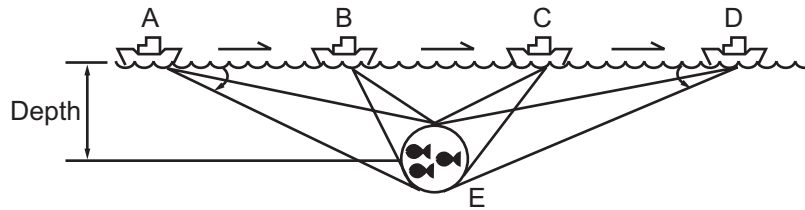

1. With the trackball, place a cross-hair cursor on the place to track.
2. Press the **TARGET LOCK** key.  
The target lock mark (⊞) is displayed on the school of fish. Tilt and range are automatically adjusted to track the position. Using the figure above as an example, the target lock mark is placed on position E. Then, the equipment stores the position E, and automatically changes the tilt angle as the ship moves from position A through D. As long as the school of fish E is stationary, its echo is kept shown on the display.
3. To disable the target lock, press the **TARGET LOCK** key again.

### 3.2 How to Detect Schools of Fish Audibly

Sometimes you may be preoccupied with other tasks, and unable to concentrate on watching the sonar picture. In such cases, use the audio function to aurally monitor the display. This function enables you to monitor echoes from schools of fish and bottom through the external speaker (optional supply). Once you get used to hearing the sound of a school of fish, you can recognize its presence without looking at the screen.

### 3.2.1 How to turn the audio on/off

To enable the audio function, input from external devices is required (see page AP-7).

1. Open the menu.
2. Select the [Sonar] tab from the main menu.
3. Select the [Sonar] tab from the sub menu.
4. Select [Audio].
5. Select [ON] or [OFF].
6. Close the menu.

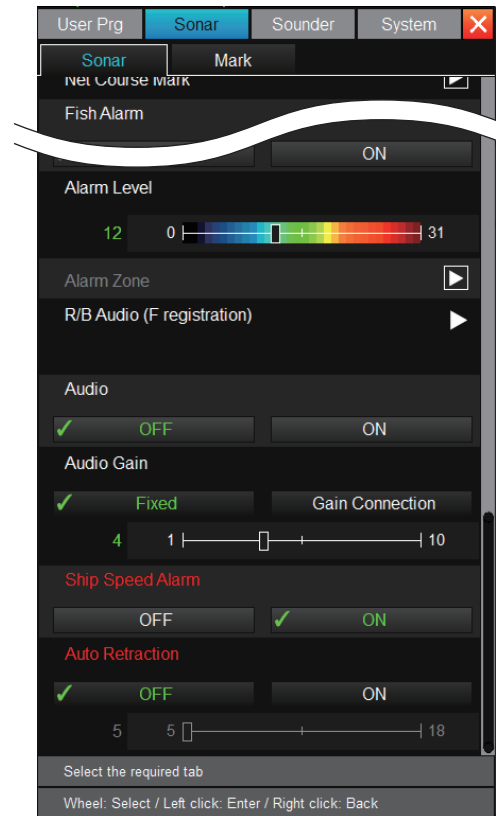

3

### 3.2.2 How to set the audio bearing

To set the audio bearing, assign the range/bearing feature to a function key.

1. If the range/bearing function is not assigned to a function key, do the following.
  - 1) Open the main menu.
  - 2) Select the [Sonar] tab from the main menu.
  - 3) Select the [Sonar] tab from the sub menu.
  - 4) Select [R/B Audio (F registration)].
  - 5) From the drop-down list, select the function key from [F1] to [F4] to assign the range/bearing function.
  - 6) Click [✓].
  - 7) Close the menu.
2. Place the cross-hair cursor on the direction you want to monitor through the speaker.
3. Press the software function key to which the range/bearing function is assigned in the step 1 above. The audio bearing marker appears on the bearing selected. When echoes from the bottom or schools of fish appear near the marker, the au-

### 3. ADVANCED SONAR OPERATION

dible alarm sounds from the speaker. When this function is turned off, the audio bearing marker changes to the bearing marker.

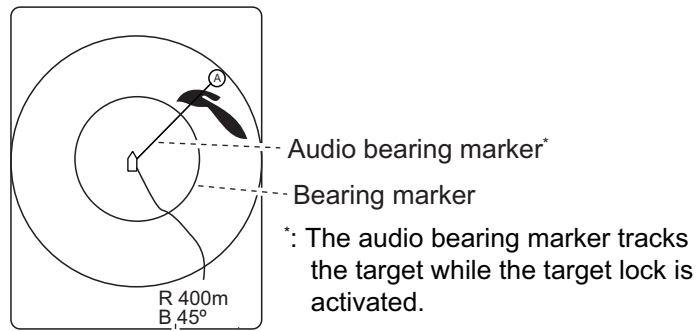

Bearing marker (slant range from the own ship position to the bearing marker) and audio bearing marker information.

**Note 1:** Place the cross-hair cursor on the own ship mark (transducer position), and press the software function key to which the range/bearing function assigned. The bearing marker and the information indicated at the bottom of the display are erased simultaneously.

**Note 2:** You can assign the range/bearing function to the optional remote controller FSV-854-MK2 or SCU-001. See chapter 6.

#### 3.2.3 How to adjust the audio volume

To adjust the audio volume (gain), do as follows.

1. Open the menu.
2. Select the [Sonar] tab from the main menu.
3. Select the [Sonar] tab from the sub menu.
4. Select [Audio Gain].
5. Select one of the following settings.
  - [Fixed]: Sets the audio volume (setting range: 1 to 10). The higher the setting, the greater the volume.
  - [Gain Connection]: The **GAIN** control, changes the audio volume. Turning the control to the right increases the volume while turning to the left decreases the volume.
6. Close the menu.



## 3.3 The Fish Alarm

The fish alarm generates an audio alarm when a fish echo above a certain strength enters the set alarm zone.

### 3.3.1 How to activate/deactivate the fish alarm

To set the fish alarm, do as follows.

1. Open the menu.
2. Select the [Sonar] tab from the main menu.
3. Select the [Sonar] tab from the sub menu.
4. Select [Fish Alarm].
5. Select [ON].
6. Select [Alarm Zone].
7. Place the cross-hair cursor on the start point of the alarm zone.
8. Click the point.
9. Place the cross-hair cursor on the end point of the alarm zone. The alarm zone is shown on the screen as illustrated below.

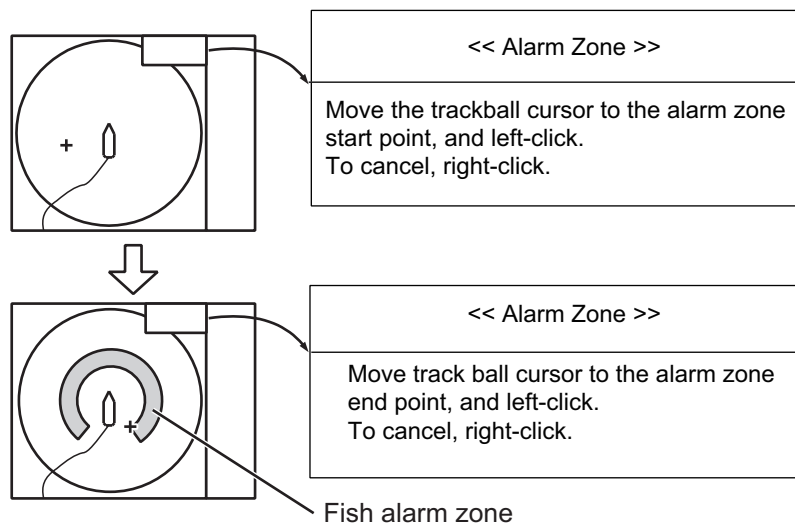

10. Click the point.
11. Close the menu. When schools of fish appear within the set zone, the alarm sounds.

**Note 1:** There must be at least  $3^\circ$  difference between the start and end points to get a fan-shaped alarm zone as shown in the figure (a) and (b). Otherwise, a  $360^\circ$  alarm zone is set as shown in the figure (c) where there is less than  $3^\circ$  between the start and end points.

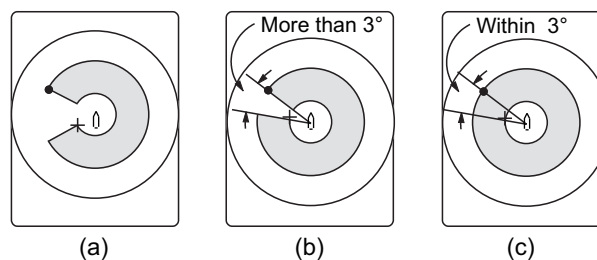

**Note 2:** To disable the alarm, select [OFF] in the step 5 above.

### 3.3.2 How to set alarm level

The alarm level sets the minimum echo strength at which the fish alarm is activated. The echo strength is equivalent to echo color.

1. Open the menu.
2. Select the [Sonar] tab from the main menu.
3. Select the [Sonar] tab from the sub menu.
4. Select [Alarm Level].
5. Select the desired echo strength. The fish alarm sounds when the echo strength is greater than the set level.
6. Close the menu.

## 3.4 How to Measure the Speed of School of Fish

To ensure a good haul, it is important to estimate the direction and speed of schools of fish before shooting the net. You can do this with the **FISH** keys. With tidal current data and fish speed data, you can determine the timing of the net shooting more efficiently. There are two types of **FISH** keys available, **FISH** key 1 ("□") and **FISH** key 2 ("◇"), and up to 20 marks can be entered. However, this function requires appropriate data input. For details, see page AP-7.

### 3.4.1 How to enter a fish mark

1. Place the cross-hair cursor on the center of a school of fish, and then press the **FISH** key. The latest fish mark ("□" or "◇") appears on the fish echo.
2. Wait for 1 to 2 minutes.
3. Place the cross-hair cursor on the same school of fish selected in step 1, and then press the same **FISH** key as in step 1.

The latest fish mark ("□" or "◇") appears on the fish echo, and the mark selected in step 1 above changes to "▣" or "◊". In addition, the range between the two fish marks, horizontal range from own ship to the latest fish mark, depth, speed, and course of the school of fish are shown at the bottom right corner of the sonar display.

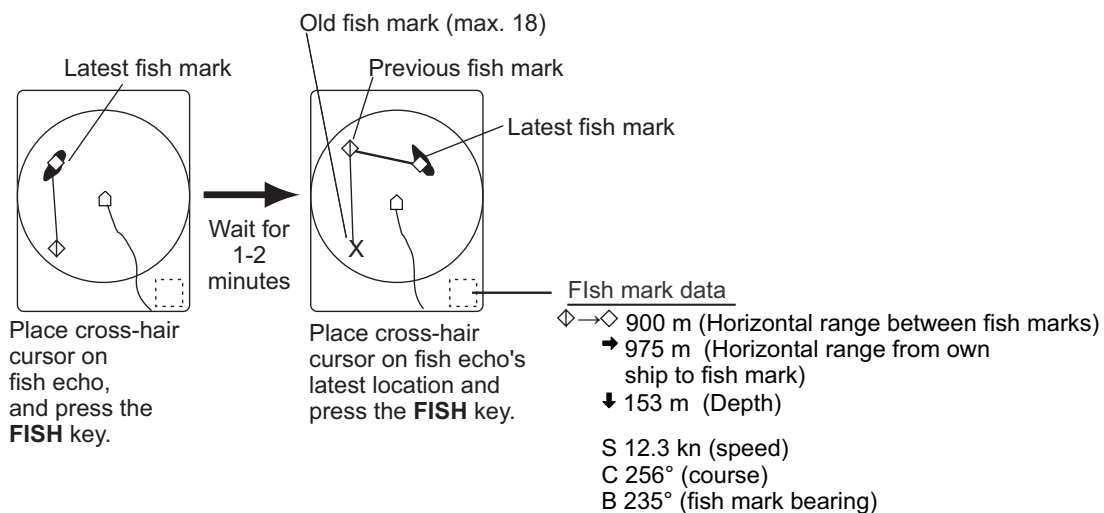

*Fish mark and fish mark data (example of FISH key 2)*

**Note 1:** The time and distance between pressings of the **FISH** key should be as long as possible to increase accuracy of measurement. For more accurate measurement, repeat the procedure two or three times.

**Note 2:** In the default arrangement, fish mark 1 can be entered on the echo display area by clicking on the display.

**Note 3:** Each time the **FISH** key is pressed, the fish mark changes in the sequence shown below. A maximum of 20 fish marks can be entered. When this amount is exceeded, the oldest fish mark is automatically erased.

**[Fish mark 1]**

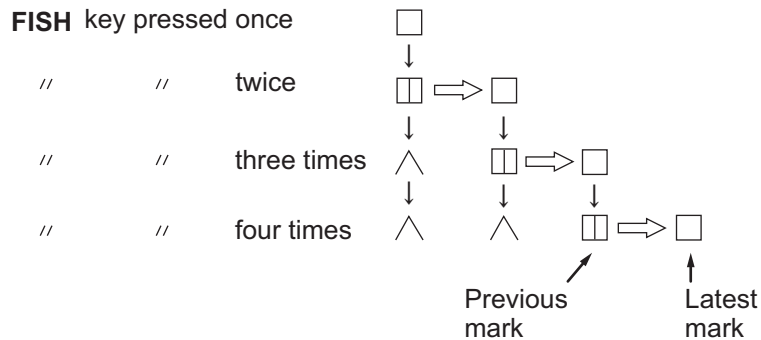

**[Fish mark 2]**

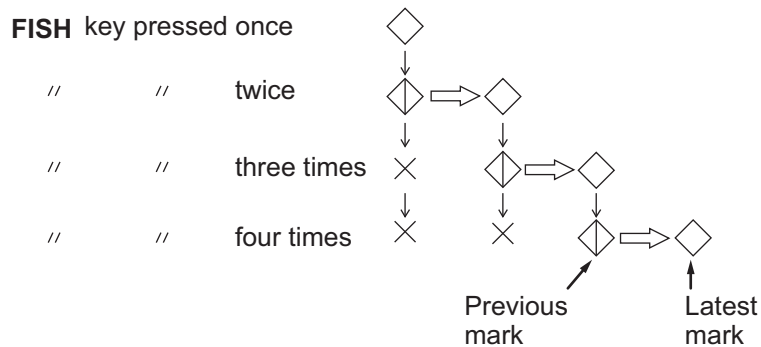

### 3.4.2 How to delete fish marks

You can delete fish marks individually or collectively. See page 9-6.

#### Erase with the DELETE MARK key

1. Place the cross-hair cursor on the fish mark to delete. The fish mark color changes to red when the fish mark is correctly selected.
2. Press **DELETE MARK** key to delete the fish mark.

#### Erase from the menu

1. Open the menu.
2. Select the [Sonar] tab from the main menu.
3. Select the [Mark] tab from the sub menu.
4. Select [Fish mark 1 erased] or [Fish mark 2 erased]. The fish mark is deleted in the order from the oldest to newest as you click.
5. Close the menu.

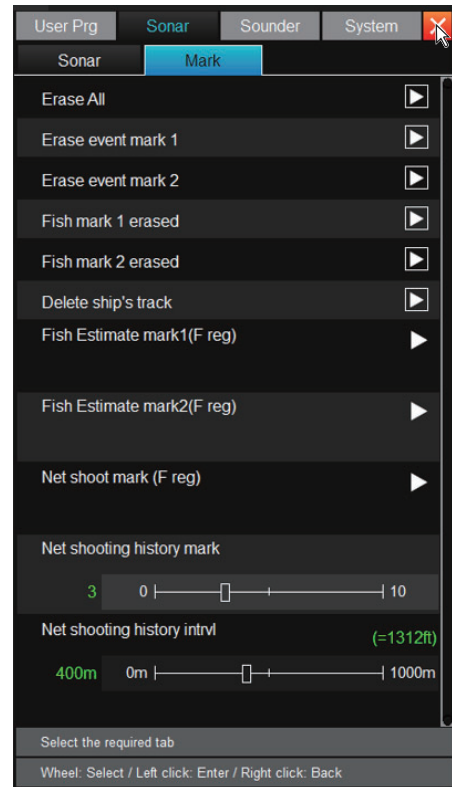

### 3.5 How to Relocate a School of Fish

The off-center function is used to relocate a school of fish on the display.

1. Place the cross-hair cursor on the position where you want to relocate the own ship mark.
2. Press the **OFF CENTER** key. The own ship mark moves to where the cursor is placed.
3. To move the own ship mark back to the screen center, press the **OFF CENTER** key again.

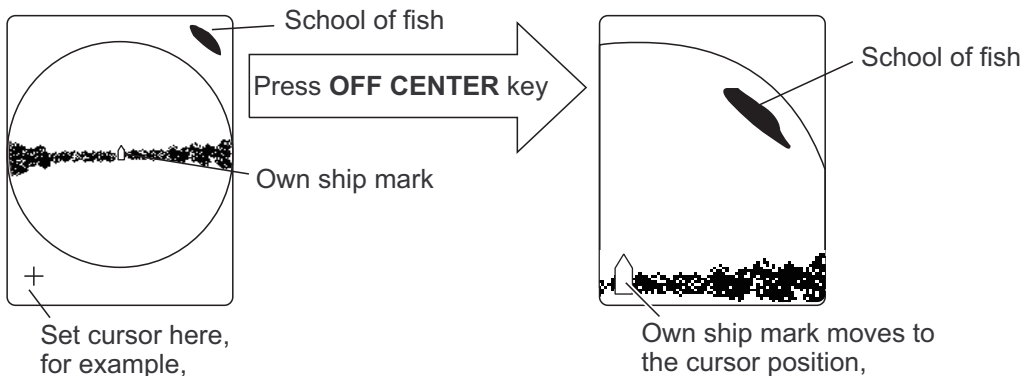

**Note:** The off-center function can also be activated by long-pressing the left button on the echo display area. To restore the normal display, long-press the right button.

## 3.6 Event Mark

The event mark is useful for finding the horizontal range, depth, and bearing to a location from the current position. There are two types of event marks: event mark 1 ( $\oplus$ ) and event mark 2 ( $\otimes$ ). Up to 20 marks can be entered for each type of event mark. This function requires appropriate data input. For details see page AP-7.

Each time an event mark is entered, the latest event mark ( $\oplus$  or  $\otimes$ ) appears at the cursor position, and all other event marks are shown by marks  $+$  or  $\wedge$  with numbers in sequential order. When the entered marks exceed 20, the oldest event mark is automatically erased.

### 3.6.1 How to enter an event mark

1. Place the cross-hair cursor where you want to enter an event mark.
2. Press the **EVENT** key. The latest event mark ( $\oplus$  or  $\otimes$ ) appears, and the horizontal range, depth, and bearing to the event mark appear at the bottom left-hand corner of the horizontal display area.

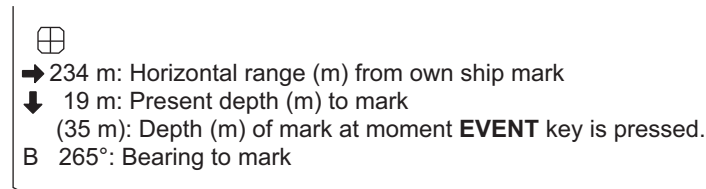

*Ex. Indications when the  $\oplus$  **EVENT** key is pressed*

With speed and heading data, the mark follows own ship's movements. When the tilt angle is changed, the present depth to the event mark changes. Note that the mark's position does not change when automatic tilt is active; the tilt center angle is used to position the mark.

Plotting the event mark on the display is equivalent to dropping a buoy with an anchoring chain that extends from the surface to the bottom (point A in the figure below). The buoy is fixed at its geographical location, but the marker on the display moves to a point where the present beam plane intersects the anchoring chain of the buoy as the ship moves or the tilt angle is changed (point B in the figure below).

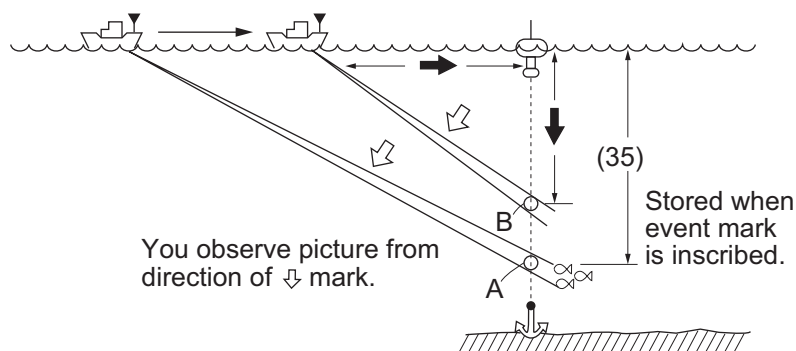

**Note:** In the default arrangement, you can use the right button to enter an event mark 1.

### 3.6.2 How to delete an event mark

You can delete event marks individually or collectively by the following procedures. See page 9-6.

#### **With the DELETE MARK key**

1. Place the cross-hair cursor on the event mark you want to delete. The color of the mark changes to red.
2. Press **DELETE MARK** key to delete the mark.

#### **From the menu**

1. Open the menu.
2. Select the [Sonar] tab from the main menu.
3. Select the [Mark] tab from the sub menu.
4. Select [Erase event mark 1] or [Erase event mark 2]. The event mark is erased in the order from the oldest to newest as you click.
5. Close the menu.

**Note:** In the default arrangement, you can use the software function key **F5** to erase event mark 1, or **F6** key to erase event mark 2 respectively, in the order from the oldest to newest.

## 3.7 How to Compare Concentration of School of Fish

You can use the [Estimate Mark 1] and [Estimate Mark 2] to get an estimate of the volume of two schools of fish. This function requires appropriate data input (see page AP-7).

There are two ways to show [Estimate Mark 1] and [Estimate Mark 2].

- From the function keys.
- From the [Select Mark] window.

### 3.7.1 Using the function keys

1. If [Estimate Mark 1] and [Estimate Mark 2] are not assigned to the function keys, do as follows.
  - 1) Open the menu.
  - 2) Open the [Sonar] tab from the main menu.
  - 3) Open the [Mark] tab from the sub menu.
  - 4) Select [Fish Estimate Mark1 (F reg)].
  - 5) From the drop-down list, select the function key from **F1** to **F4** to assign the [Estimate Mark 1] function.
  - 6) Click [✓].
  - 7) Select [Fish Estimate Mark2 (F reg)].

- 8) From the drop-down list, select the function key from **F1** to **F4** to assign the [Estimate Mark 2] function.
  - 9) Click [✓].
  - 10) Close the menu.
2. Press the function key to which the [Estimate Mark 1] function is assigned. The estimate mark 1 appears.

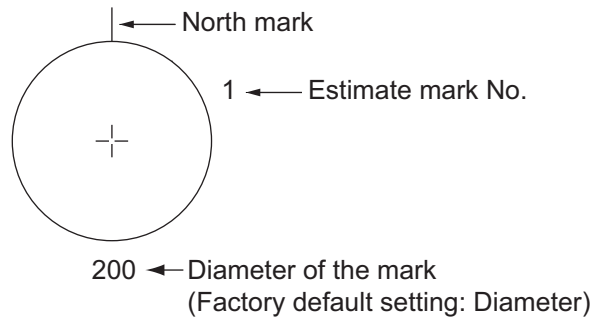

3. Move the estimate mark 1 to the fish echo you want to get an estimate of the volume.
4. Turn the wheel knob to adjust the diameter for the estimate mark 1. For an accurate estimate, adjust the size so that schools of fish are within the estimate mark 1 area.
5. Click on the screen. The estimate mark 1 is fixed at the position, and school of fish information is shown on the data display area. See page 3-12.  
**Note:** The mark color changes to red when the cross-hair cursor is placed on the estimate mark. With this condition, turn the wheel knob to adjust the estimate mark size.
6. Do the same procedure for estimate mark 2. You can compare the concentration of two schools of fish.
7. To erase the estimate marks, press the function key to which the [Estimate Mark 1] or [Estimate Mark 2] is assigned.

**Note 1:** If the estimate mark 1 is synchronized with a target lock mark, the estimate mark 1 cannot be erased in the step 7 above.

**Note 2:** You can assign the estimate mark 1 or estimate mark 2 to the optional remote controller FSV-854-MK2 or SCU-001. See chapter 6.

### 3.7.2 Using the [Select Mark] window

1. Long-press the wheel knob to show the [Select Mark] window.

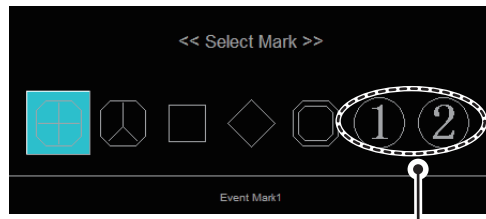

Estimated mark 1 & 2

2. Select [1] (estimate mark 1).
3. Click on the screen to show the estimate mark 1.
4. Move the estimate mark 1 over the fish echo you want to get an estimate of the volume.
5. Turn the wheel knob to adjust the size of the estimate mark 1. For an accurate estimate, adjust the size so that the fish echo is within the set estimate mark 1.
6. Click on the screen. Estimate mark 1 is fixed at the position, and school of fish information is shown on the data display area.
 

**Note:** The mark color changes to red when the cross-hair cursor is placed on the estimate mark. In this condition, turn the wheel knob to adjust the estimate mark size.
7. Do the same procedure for the estimate mark 2. You can compare the concentration of two schools of fish.
8. To erase the estimate marks, select the estimate mark on the [Select Mark] window, then click on the screen.

#### School of fish

When a fish estimate mark is entered, information about the school is shown on the data display area.

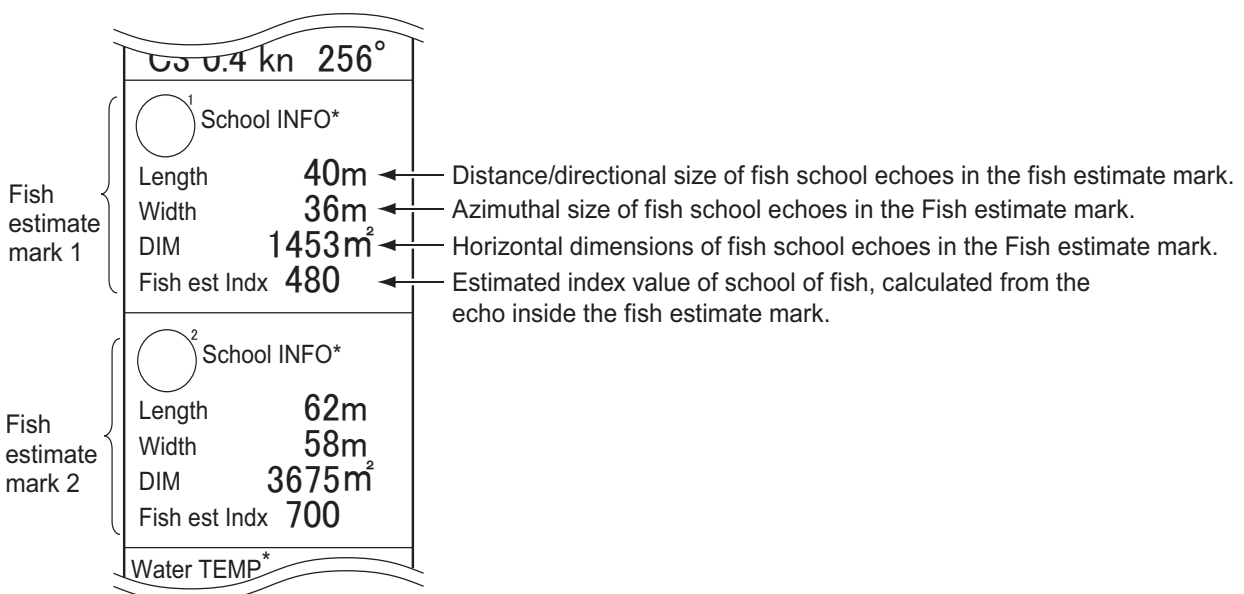

**Note:** When a new fish estimate mark is entered right after an estimate mark is erased, the fish information for the new mark is reflected after five transmissions.



## 3.8 Select Mark Window

[Event Mark 1], [Event Mark 2], [Fish Mark 1], [Fish Mark 2], [Target Lock], [Estimate Mark 1], and [Estimate Mark 2] can be entered from the [Select Mark] window.

1. Long-press the wheel knob to show the [Select Mark] window.



Name of selected mark

2. Select the mark on the window above.
3. Click on the screen where you want to enter the mark.

3

## 3.9 Net Course Mark

Before shooting the net, determine the shoot timing considering tide direction, distance to the school of fish, and moving direction of the school of fish. Use the net course mark as a guide to determine the timing. This function requires appropriate data input (see page AP-7).

### How to enter the net course mark

1. Open the menu.
2. Select the [Sonar] tab from the main menu.
3. Select the [Sonar] tab from the sub menu.
4. Select [Net Course Mark]. The instructions for how to set the net course appear on the screen.

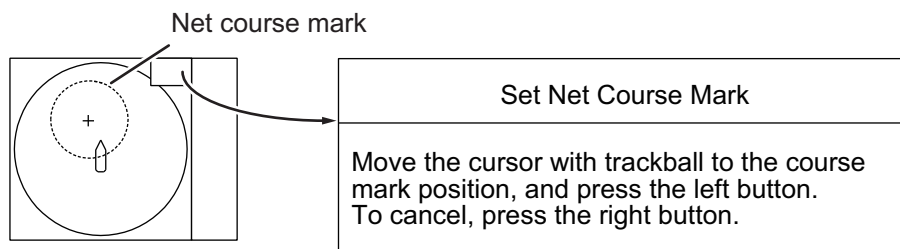

**Note:** Right-click on the display to cancel the net course mark operation. Note that the cancel operation is invalid if the cursor is located on the fish finder display.

5. Move the net course mark where you want to set.
6. Click on the display. The dash line changes to a solid line.
7. Close the menu.

**Note:** To erase the net course mark, repeat steps 1 to 4 above.

## 3.10 Net Data

Using the net shoot mark, you can observe net data after shooting the net. This function requires appropriate data input (see page AP-7).

### 3.10.1 How to set the net shooting history

After the net shoot mark is entered, the net shooting history mark appears at the own ship position with the interval between marks set in advance (max. 10 marks).

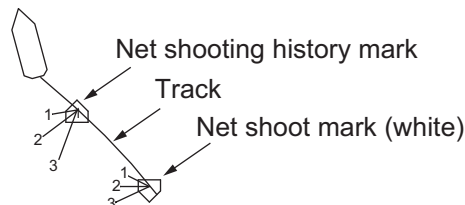

1. Open the menu.
2. Select the [Sonar] tab from the main menu.
3. Select the [Mark] tab from the sub menu.
4. Select [Net shooting history mark].
5. Select the number of marks to be displayed. See the table below for mark shapes and colors.

Shape	Color	Shape	Color
①	Orange	⑥	Blue
②	Purple	⑦	Green
③	Light blue	⑧	Brown
④	Yellow	⑨	Gray
⑤	Red	⑩	White

6. Select [Net shooting history intrvl].
7. Set the display interval for the mark (range: 0 to 1000 m).
8. Close the menu.

### 3.10.2 How to use the net shoot mark

To enter the net shoot mark, assign the net shoot mark function to a function key.

1. If the net shoot mark function is not assigned to a function key, do as follows.
  - 1) Open the menu.
  - 2) Select the [Sonar] tab from the main menu.
  - 3) Select the [Mark] tab from the sub menu.
  - 4) Select [Net shoot mark (F reg)].
  - 5) Select the function key from [F1] to [F4] to assign the net shoot mark function.
  - 6) Click [✓].
  - 7) Close the menu.
2. Press the function key set above immediately after the net shoot. The net shoot mark (□) appears, and the bearing from the net moving start point, and the time elapsed from the net shooting are displayed at the top of the screen. After the net shoot mark is entered, the net shooting history mark appears at the own ship position with the interval set in subsection 3.10.1. Three current layers of the net

move plot marks are displayed. The net move plot marks show how the net is being swept by the current.

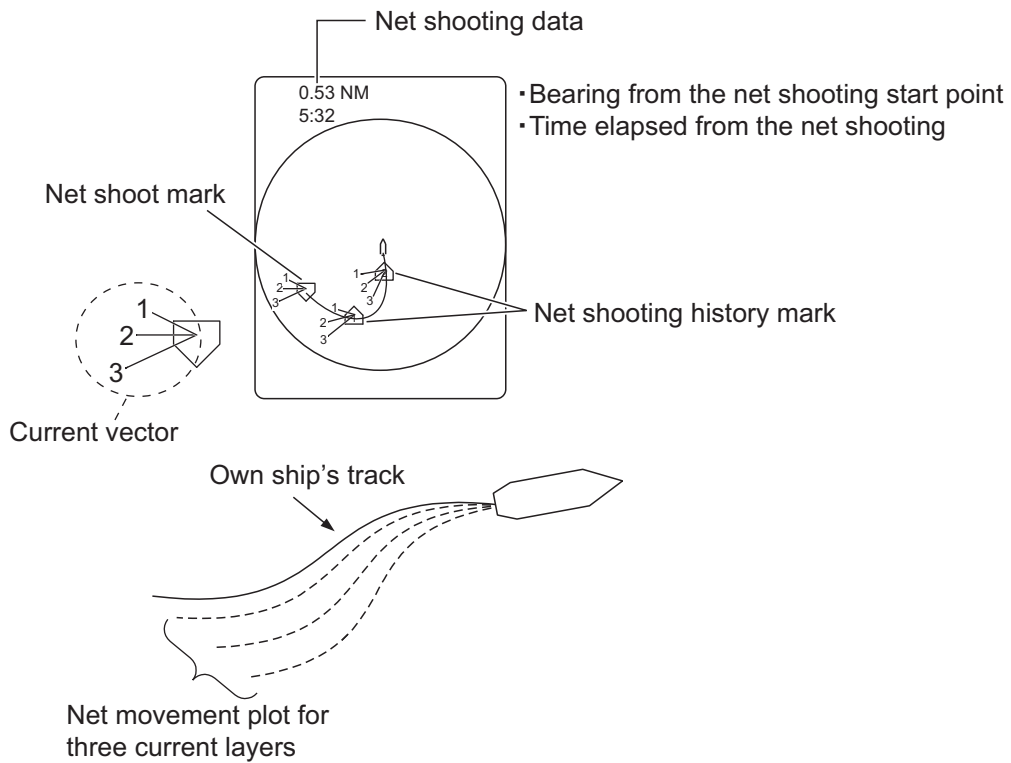

**Note:** While the net shoot mark appears on the screen, the number or interval of net shooting history mark cannot be changed. Also, the track data (depth or water temperature) is not shown on the track.

- To erase the net shoot marks, net shooting history marks, and net shooting data, press the function key to which the net shoot mark function is assigned.

**Note 1:** You can assign the net shoot mark functions to the optional remote controller FSV-854-MK2 or SCU-001. See chapter 6.

**Note 2:** If the current vector or net movement plot mark is not shown, contact your dealer.

### 3. ADVANCED SONAR OPERATION

This page is intentionally left blank.

# 4. FISH FINDER MODE

This equipment can show the picture from the fish finder in combination with the sonar echoes.

**Note:** Connection to a fish finder is required to use the fish finder dual display mode.

## 4.1 Fish Finder Display Overview

The figure below shows the items that appear on the fish finder display.

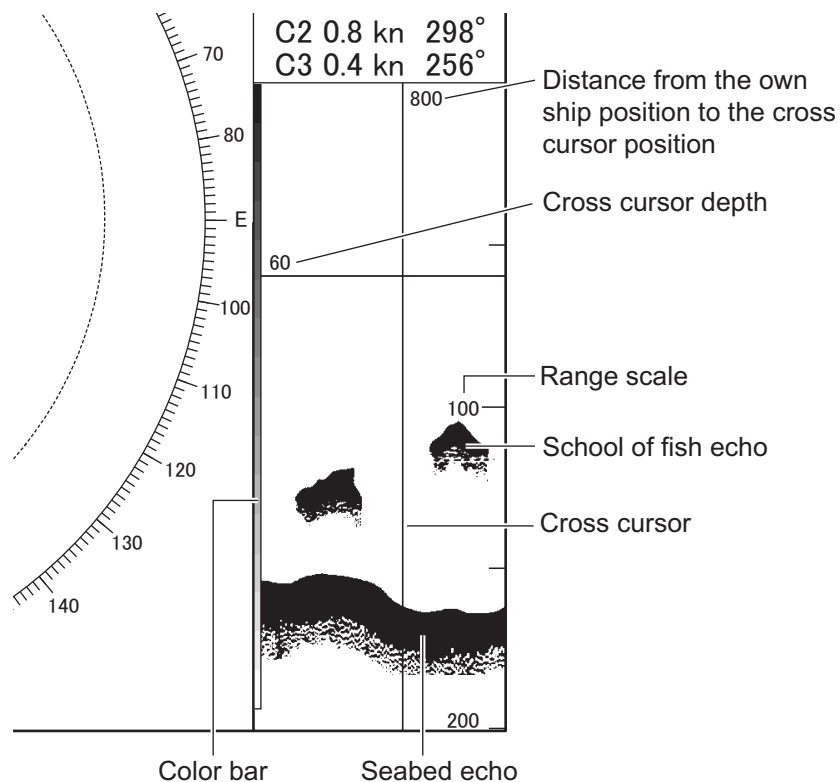

*Fish finder display example*

## 4.2 How to Select a Display Range

The basic range and range shifting functions together give you the means to select the depth you can see on the screen. The basic range can be thought of as providing a “window” into the water column, and range shifting as moving the “window” to the desired depth.

**Note:** Use the same settings as the connected fish finder. Fish finder settings changed on the sonar are not reflection to the fish finder.

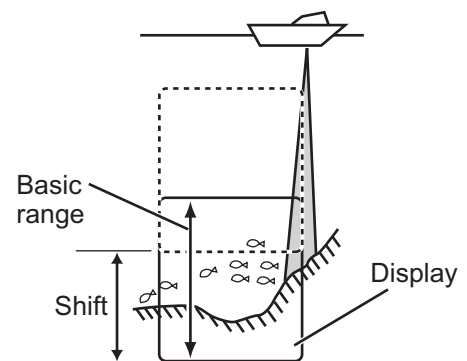

## 4. FISH FINDER MODE

1. Open the menu.
2. Select the [Sounder] tab from the main menu.
3. To set the range, select [Range].
4. Set the range (setting range: 5 m to 1000 m).
5. To set the shift, select [Shift].
6. Set the shift (setting range: 0 m to 1000 m).
7. Close the menu.

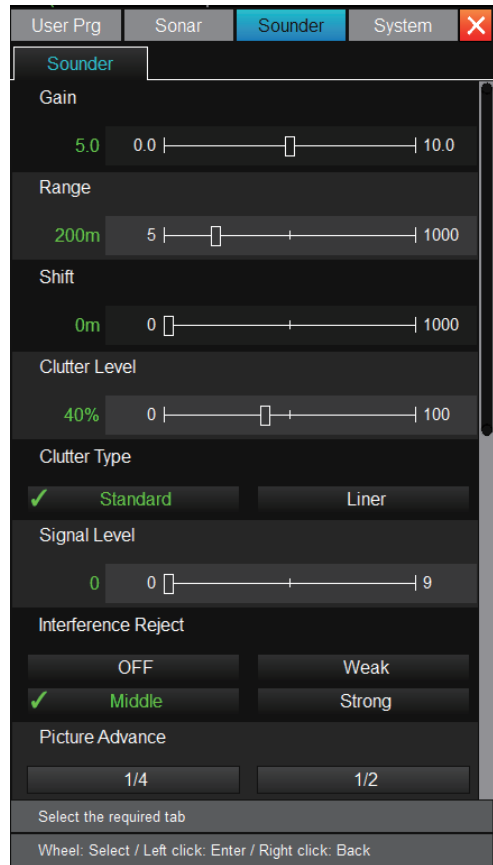

### 4.3 How to Adjust the Gain

You can adjust the display gain of the fish finder picture as below.

**Note:** Use the same settings as the connected fish finder. Fish finder settings changed on the sonar are not reflection to the fish finder.

1. Open the menu.
2. Select the [Sounder] tab from the main menu.
3. Select [Gain].
4. Set the gain (setting range: 0.0 to 10.0).
5. Close the menu.

## 4.4 How to Select Picture Advance Speed

The picture advance speed determines how quickly the vertical scan lines run across the screen. When selecting a picture advance speed, keep in mind that a fast advance speed expands a school of fish horizontally while a slow advance speed contracts it.

**Note:** Use the same settings as the connected fish finder. Fish finder settings changed on the sonar are not reflection to the fish finder.

1. Open the menu.
2. Select the [Sounder] tab from the main menu.
3. Select [Picture Advance].
4. Set the picture advance speed. 1/4 is the slowest advance speed (one scan line is produced for every four transmissions), and 4/1 is the fastest speed (four scan lines are produced for every transmission).
5. Close the menu.

## 4.5 How to Measure Depth and Distance

You can measure the depth and distance from the own ship position to the cross-hair cursor position. Use the trackball to place the cross-hair cursor on the location where you want to measure the depth and distance.

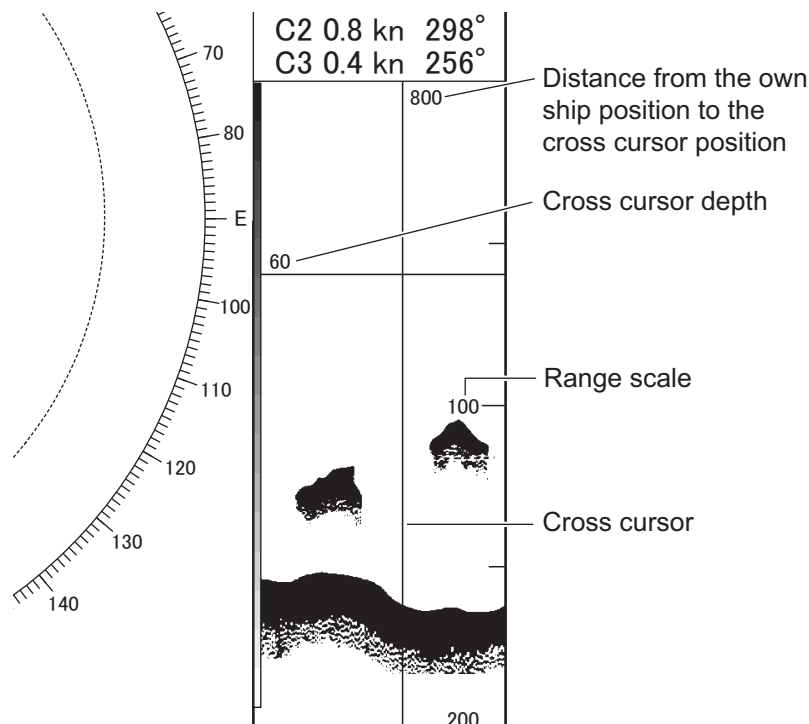

## 4.6 How to Suppress Interference

Interference from other sonars being operated on other ships nearby, or induction noise from electronic equipment on your ship may appear on the display. These types of interference can be reduced with the interference rejector.

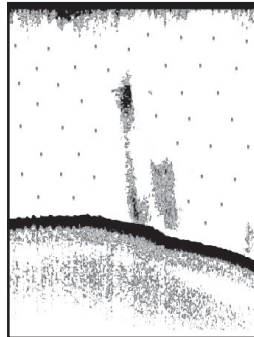

Interference from other fish finders



Electrical interference

To remove interference, do as follows.

1. Open the menu.
2. Select the [Sounder] tab from the main menu.
3. Select [Interference Reject].
4. Adjust the setting.  
[Strong] provides the greatest degree of suppression, and [Weak] provides the weakest. [OFF] turns off the interference rejector.  
**Note:** A high setting may also remove weak echoes (small targets).
5. Close the menu.

## 4.7 How to Reject Low Level Noise (Clutter)

Low level noise, often caused by sediments in water, is painted on the screen as a large number of light-blue dots. These echoes may be rejected as shown below.

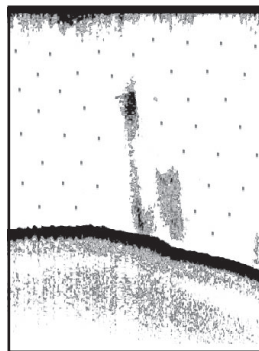

1. Open the menu.
2. Select the [Sounder] tab from the main menu.
3. Select [Clutter Level].
4. Adjust the range (setting range: 0 to 100%). The higher the number the stronger the effect.
5. Select [Clutter Type].



6. Select one of the following color settings.
  - [Standard]: Strong color echoes are displayed as they are, and weak echoes are shown smaller, when the clutter level is increased.
  - [Liner]: All echoes are displayed smaller, when the clutter level is increased.
7. Close the menu.

## 4.8 How to Erase Weak Echoes

Sediments in the water or reflections from planktons may be painted on the display in low intensity tones, as shown in the figure below. You can remove these unwanted echoes with the color erase feature.

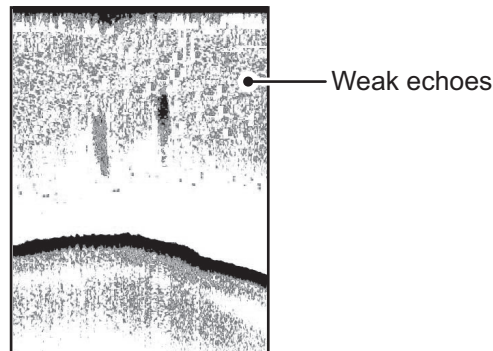

1. Open the menu.
2. Select the [Sounder] tab from the main menu.
3. Select [Signal Level].
4. Adjust the range (setting range: 0 to 9). As the setting increases, reflections are removed in order, from weakest to strongest.
5. Close the menu.

## 4.9 How to Adjust TVG (Time Varied Gain)

A school of fish at a deep depth is displayed in weak colors even if it is equal in strength to one in shallow waters. This is due to propagation attenuation of the ultrasonic wave. To compensate for this difference, use TVG. TVG automatically adjusts the gain with depth so that echoes of the same strength and different depths are shown in the same colors regardless of their depths. The gain is increased with depth to display echoes of equal strengths in the same colors. In the following figure, for example, the TVG is set for 100 m and the TVG level is adjusted. Then, unwanted echoes at a distance less than 100 m are suppressed, and echoes at depths greater than 100 m are not affected.

## 4. FISH FINDER MODE

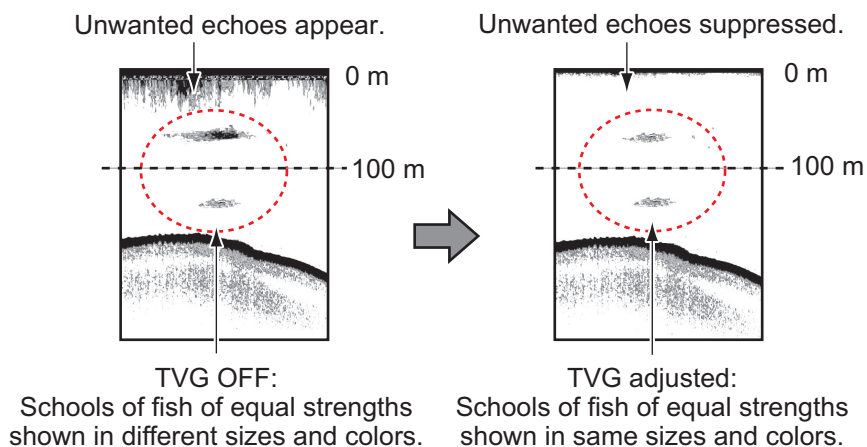

1. Open the menu.
2. Select the [Sounder] tab from the main menu.
3. Select [TVG Distance].
4. Set the distance for TVG (setting range: 30 to 1000 m).
5. Select [TVG Level].
6. Adjust the range (setting range: 0 to 9). The higher setting reduces the gain at a short distance.
7. Close the menu.

### 4.10 Smoothing

If echoes appear like “patchwork”, turn this feature on to smooth them. This feature is effective to reduce screen flickers at night.

1. Open the menu.
2. Select the [Sounder] tab from the main menu.
3. Select [Smoothing].
4. Select [ON].
5. Set the smoothing level (setting range: 1 to 9). The higher setting makes the images smoother.
6. Close the menu.

## 4.11 How to Remove Unwanted Echoes Near the Surface

The STC feature can remove unwanted echoes (air bubbles, planktons, etc.) near the surface. Use this function when you want to see fish near the surface clearly.

1. Open the menu.
2. Select the [Sounder] tab from the main menu.
3. Select [STC Level].
4. Set the STC level (setting range: 0 to 10).  
"0" turns off the STC. With the setting 10, STC removes unwanted echoes from the surface to about 5 m. If the setting is too high, fish echoes near the surface may be removed.
5. Close the menu.

## 4.12 TX and RX Settings

**Note:** Use the same settings as the connected fish finder. Fish finder settings changed on the sonar are not reflection to the fish finder.

1. Open the menu.
2. Select the [Sounder] tab from the main menu.
3. Select [TX/RX Mode].
4. Select the TX/RX mode same as that of the fish finder, either [Standard] or [TruEcho CHIRP].  
When FCV-1200L/1500L is selected as the fish finder source, TX/RX mode is fixed to [Standard] while [TruEcho CHIRP] cannot be selected.
5. Select [Transmission Pulse].
6. Select the same transmission pulse as that set on the fish finder, [Very Short(1/4)], [Short(1/2)], [Standard], [Long(X2)], or [Manual].
7. When [Manual] is selected, use the same transmission pulse as set on the fish finder.
8. Close the menu.

#### 4. FISH FINDER MODE

This page is intentionally left blank.

# 5. NUMERIC AND GRAPHIC DATA DISPLAY AREA

## 5.1 Numeric and Graphic Data Display

The following numeric/graphic data are shown on the right side of the horizontal single display.

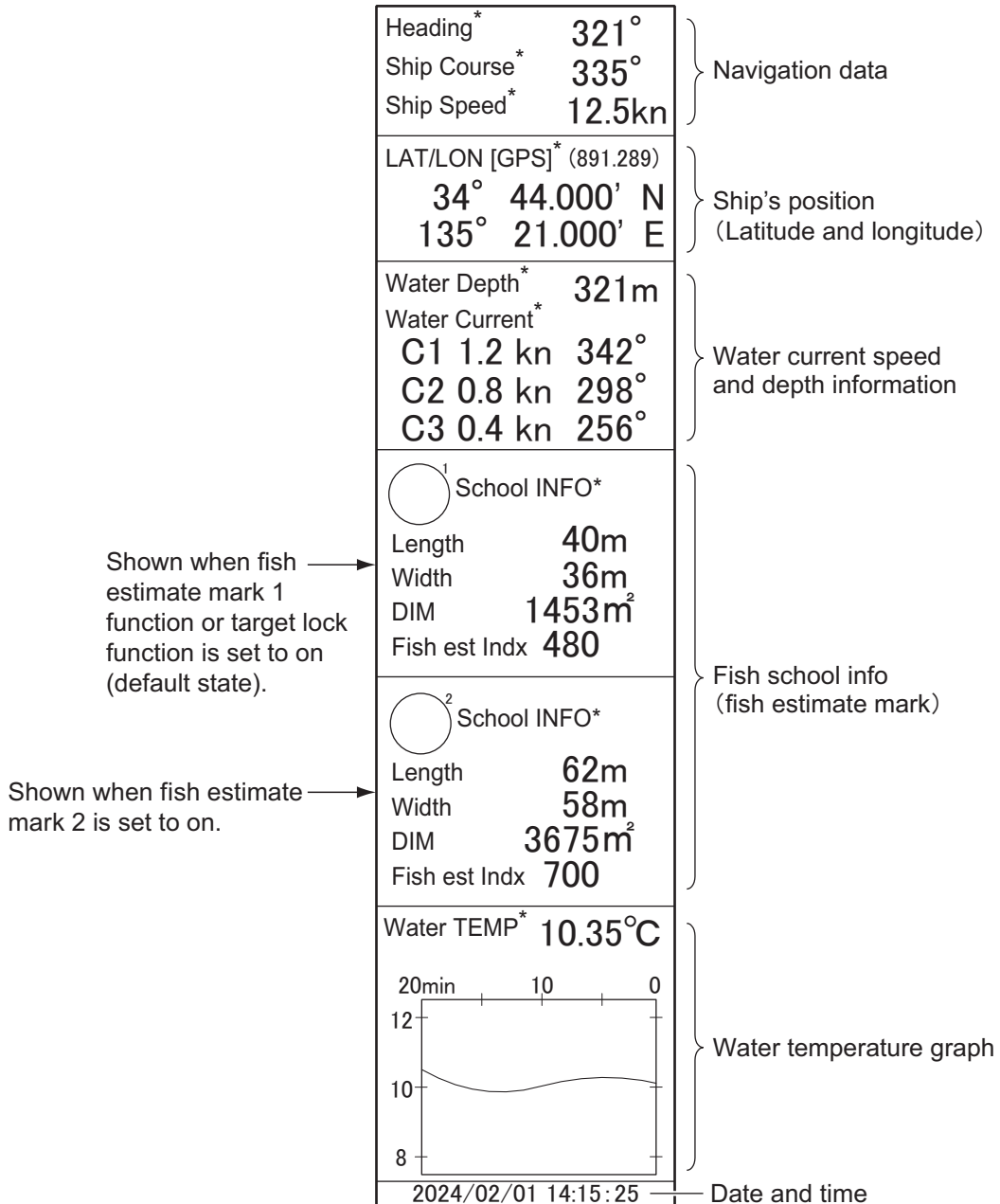

\*: Compatible sensor is required (see page AP-7).

## 5.2 Numeric/Graphic Data Description

When data is lost, the last value is shown in red. Information displayed on the screen can be changed to on or off from the system menu. For details about the system menu, contact your dealer.

<b>Numeric &amp; Graphic item</b>	<b>Description</b>	<b>Display range</b>	<b>Available formats</b>
<b>Navigation</b>			
Heading	Shows heading input from heading sensor.	32 compass pts. 0° to 359°	32 compass pts. 360°
Ship Course	Shows ship course fed from navigational devices.	32 compass pts. 0° to 359° 0° to 359° 1 to 179°P/S, 0°, 180°	32 compass pts. 360° (True) 360° (Relative) ±180° (Relative)
Ship Speed	Shows ship speed fed from navigational devices.	0.0 to 99.9 kn	Fixed at knots
<b>Own ship position</b>			
Position sensor	The position sensor type is displayed in brackets. When the position sensor is not connected, nothing appears between the brackets. In case of positioning error, "****" appears.	DGPS: Differential Global Positioning Systems KGPS: Kinematic Global Positioning Systems (FIX) FGPS: Kinematic Global Positioning Systems (FLOAT) GPS: Global Positioning System	
LAT/LON	Shows own ship position in latitude and longitude.	Latitude: 90°00.000S to 90°00.000N Longitude: 179°59.999W to 179°59.999E, 180°00.000, 0°00.000	L/L
<b>Depth and current</b>			
Water Depth	Shows depth from transducer to bottom.	0 to 9999 m	m
Water Current	Shows tide speed and direction for three layers, or differential tide speed for two layers fed from the current indicator.	Layer: C1 to C5 Cur. Spd: 0.0 to 9.9 kn Direction: 32 compass pts., 0° to 359°	32 compass pts. 360°
<b>School of fish</b>			
Length	Distance (or length) of fish school in range direction for Fish Mark 1&2.	0 to 999 m	m
Width	Distance (or length) of fish school in bearing direction for Fish Mark 1&2.	0 to 999 m	m
DIM	Area of fish school for Fish Mark 1&2.	0 to 99999 m <sup>2</sup>	m <sup>2</sup>

<b>Numeric &amp; Graphic item</b>	<b>Description</b>	<b>Display range</b>	<b>Available formats</b>
Fish est Indx	Estimated index value of fish school, calculated from the echo for Fish Mark 1&2.	0 to 9999	
<b>Water temperature</b>			
Water TEMP	Shows water temperature input from a temperature sensor.	-10.00°C to 40.00°C 14.00 to 104.00°F	°C, °F
Water TEMP graph	Shows water temperature over time.	Horizontal axis (time): 20 min, 1 hr, 6 hrs, 12 hrs, 24 hrs Vertical axis (water temp.): 4°C or 8°F, fixed width, auto shift	°C, °F
<b>Date and time</b>			
Date, time	Shows current date and time.		Year/Month/Date/ Hour/Minute/Second

5. NUMERIC AND GRAPHIC DATA DISPLAY AREA

This page is intentionally left blank.



# 6. HOW TO CUSTOMIZE THE SONAR

This chapter describes how to use the function keys, user program control, remote controller FSV-854-MK2 (option), and remote controller SCU-001 (option). Also, restoration of scan settings is described.

## 6.1 Function Keys

Often-used menu items can be assigned to the function keys to enable quick access to those items. In the default arrangement, following functions are assigned to the software function keys.

Function key	Function	Description
F1	Record Still Images	Saves the still images.
F2	Play Still Images	Plays the latest still image files.
F3	Motion Image	Opens the [Motion Image] window.
F4	Erase All	Erases all event marks (1/2) and fish marks (1/2).
F5	Erase event mark 1	Erases event mark 1.
F6	Erase event mark 2	Erases event mark 2.
F7	Frequency Shift	Changes the transmission frequency.
F8	Near Gain	Changes the near gain settings.
F9	Far Gain	Changes the far gain settings.
F10	Transmission	Turns transmission ON/OFF.

### 6.1.1 How to operate the function keys

For F1 to F4, you can access them from the control unit and on the display while F5 to F10 can only be accessed from the display. For how to operate the function keys from the display, see section 1.6.

1. Press the desired function key. If the function other than [Record Still Images] or [Play Still Images] is assigned to a function key, the setting window appears. In the example here, the [Erase All] setting window is shown.

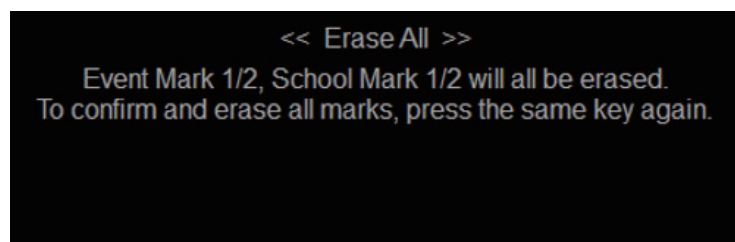

When the F4 key is selected (factory default setting)

- Note:** Depending on the registered function, the operation in step 2 may not be necessary.
2. Press the same function key again within five seconds to execute the program. The dialog box automatically disappears in five seconds. You can also close the dialog box manually by pressing any function key other than the one pressed at step 1.

## 6.1.2 How to assign menu items to the function keys

To assign other menu items to the function keys (or software function keys), do as follows.

**Note 1:** Some menu items cannot be assigned to the function keys. See the menu tree on page AP-1 for details.

**Note 2:** The list of the menu items assigned to the function keys can be confirmed with the software function key at the bottom of the screen. See section 1.6.

1. Place the cursor on the menu item that you want to assign to the function key. The item is framed with a light-blue rectangle.
2. Left-click on the menu item, and hold it for one second or more.

### **When the item selected at step 1 is NOT assigned to a function key**

The following message appears.

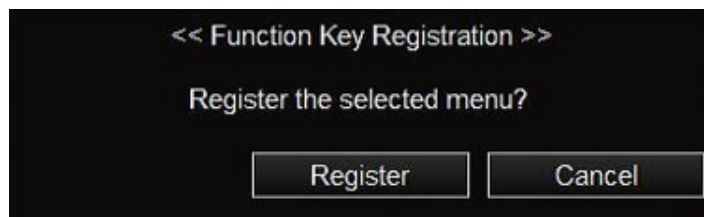

- 1) Select [Register]. The following message appears.

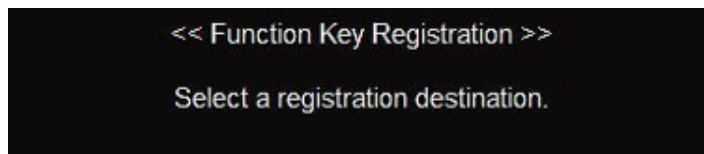

- 2) Select the function key to assign the menu item, using the software function key.

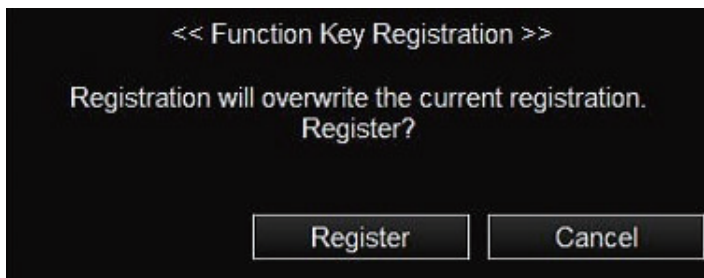

- 3) Select [Register]. The following message appears for five seconds to show that the menu item is successfully assigned to the function key.

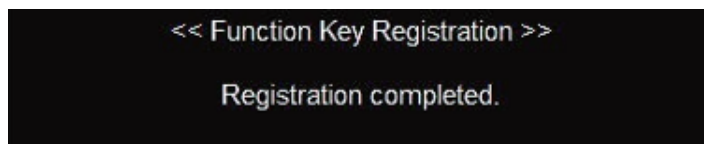

### **When the item selected at step 1 is already assigned to the function key**

The following message appears, and the currently assigned software function key is highlighted.



- 1) To continue, select [Replaced]. The following message appears.

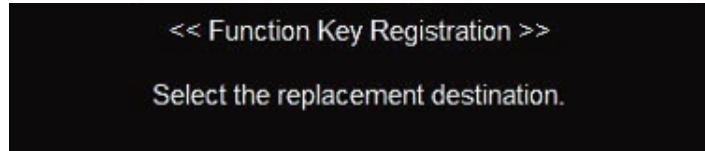

- 2) Select the function key to be replaced, using the software function key. The following message appears for five seconds to show that the menu item is successfully replaced to the function key.

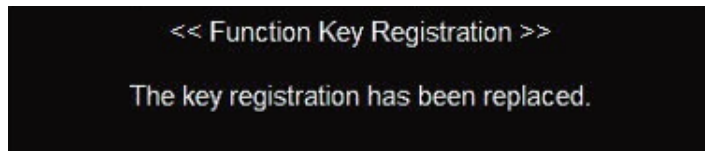

## 6.2 User Programs

The **USER PROG** control provides for instant setup of the equipment according to fishing ground or target fish. Up to ten programs may be set up. The table below shows present numbers and their default settings.

Preset No.	Settings	
P1 (Title: Surf1_PB)	For searching large-sized single fish near the sea surface. (Gain: high) Recommended gain: 4.5 to 5.5	For pleasure boat settings
P2 (Title: Surf2_PB)	For searching large-sized single fish near the sea surface. (Gain: low) Recommended gain: 6.5 to 7.0	
P3 (Title: Midd1_PB)	For searching large-sized single fish near the midwater. (Gain: middle) Recommended gain: 4.5 to 5.5	
P4 (Title: Midd2_PB)	For searching large-sized single fish near the midwater. (Gain: high) Recommended gain: 4.5 to 5.5	
P5 (Title: GainL_PB)	Set close to the tint of the fishing boat. Recommended gain: 4.5 to 5.5	
P6 (Title: Gain1_PS)	The higher preset number has the higher gain. Recommended gain: 4.5 to 5.5 (Target fish: mackerel, sardine, tuna, etc.)	For purse seiner settings
P7 (Title: Gain2_PS)		
P8 (Title: Gain3_PS)		
P9 (Title: Gain4_PS)		
P10 (Title: Net_PS)	For checking the net condition. Recommended gain: 4.5 to 5.5	

### 6.2.1 How to select a user program

Rotate the **USER PROG** control clockwise or counterclockwise to select the program number from P1 to P10. The program number selected appears at the top right corner of the screen, to the right of "P". If the equipment is turned off when a user program is active, the last-used program is activated at the next power on.

**Note:** The program No. color changes to light blue when placing the cursor on the program No. In this condition, turn the wheel knob to change the settings.

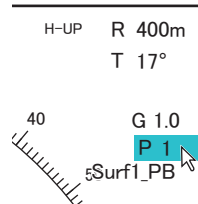

### 6.2.2 How to set the user program

1. Set the display appropriately according to the fishing ground or target fish.
2. Open the menu.
3. Select the [User Prg] tab from the main menu.



4. Select [Register User prog], then a confirmation message appears.

5. Select [Yes].



Text box

6. From the drop-down list, select a number from [P1] to [P10]. A maximum of ten presets can be registered.
7. Do the operations below to enter the user program title. The title entry column is located under the preset number.
  - 1) Click on the text box to show the software keyboard.
  - 2) Enter the title by clicking the characters on the software keyboard (maximum of 8 characters). See page 1-8 for how to enter the characters.
  - 3) Click [Enter] to finish.
8. Click [✓].
9. Close the menu.

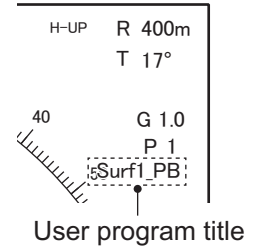

## 6.3 How to Restore Scan Settings (Range, Tilt Angle, Gain)

The range, tilt angle, and gain set for scanning can be restored to its preset value. There are two ways to set the presets.

### 6.3.1 How to preset the range, tilt angle, and gain values

The following values are preset at factory default.

	Scan setting 1	Scan setting 2
Range	150 m	300 m
Tilt angle	0°	60°
Gain	OFF	OFF

1. Open the menu.
2. Select the [Sonar] tab from the main menu.

## 6. HOW TO CUSTOMIZE THE SONAR

3. Select the [Sonar] tab from the sub menu.
4. To change range, select [Reset Range 1] or [Reset Range 2].
5. Select one of the following options.
  - [OFF]: To keep the current range after restoring the settings.
  - Drop-down list: The setting is restored to the range selected from the drop-down list.
6. To change the tilt angle, select [Reset tilt angle 1] or [Reset tilt angle 2].
7. Select one of the following options.
  - [OFF]: To keep the current tilt angle after restoring the settings.
  - [ON]: The setting is restored to the tilt angle selected here.
8. To change the gain, select [Reset Sensitivity 1] or [Reset Sensitivity 2].
9. Select one of the following options.
  - [OFF]: To keep the current gain after restoring the settings.
  - [ON]: The setting is restored to the gain selected here.
10. Close the menu.

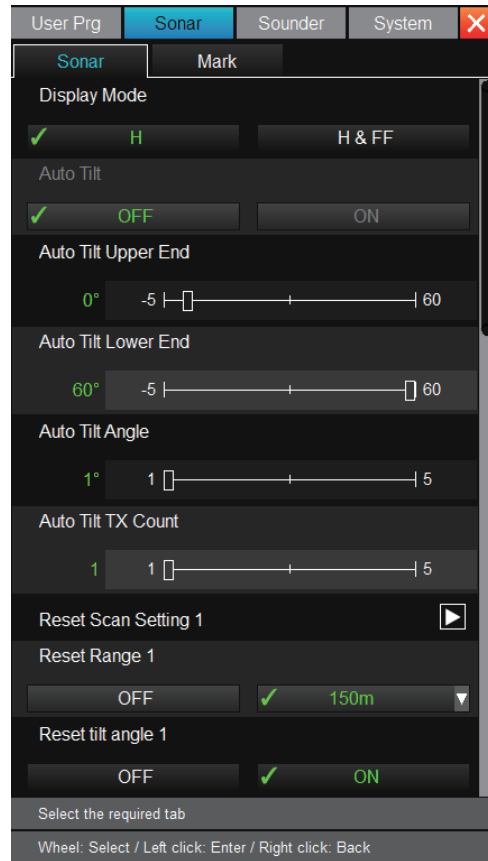

### 6.3.2 How to restore the settings for scanning

To restore the range, tilt angle, and gain settings, do as follows.

**Note:** This function is disabled when the auto tilt function is active while the [Reset tilt angle 1] or [Reset tilt angle 2] is set to other than [OFF].

1. Open the menu.
2. Select the [Sonar] tab from the main menu.
3. Select the [Sonar] tab from the sub menu.
4. Select [Reset scan setting 1] or [Reset scan setting 2]. The setting values are restored to what was set in subsection 6.3.1
5. Close the menu.

## 6.4 Remote Controller FSV-854-MK2 (Option)

The keys on the remote controller can be reprogrammed with the functions of your choice.

1. Open the menu.
2. Select the [System] tab from the main menu.
3. Select the [InitSetting] from the sub menu.

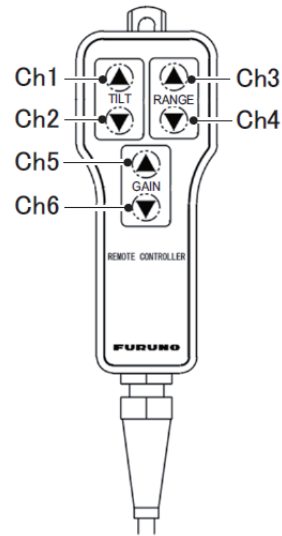
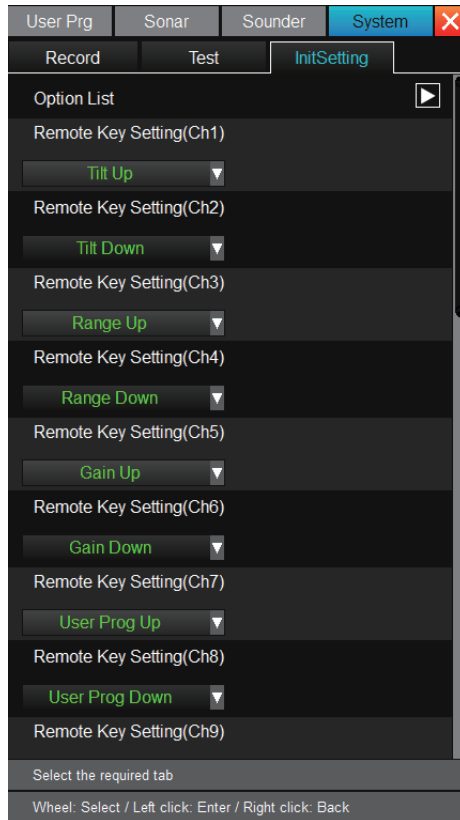

**Note:** The settings for Ch7 to Ch10 are available only when an external switch is connected to the processor unit (TB1).

4. Select the menu item corresponding to the key whose setting you want to change.
5. From the drop-down list, select the function to assign to the key.
6. Close the menu.

## 6.5 Remote Controller SCU-001 (Option)

**Note 1:** For the precautions for safety and use, see the user guide (C12-02301) shipped with the remote controller SCU-001.

**Note 2:** Only one Bluetooth® adapter (local supply) can be connected to a single processor unit.

### 6.5.1 How to set up Bluetooth® pairing

Transmission between the processor unit and remote controller is done using Bluetooth®. However, to use a remote controller, you need to pair the processor unit with the remote controller. A maximum of four remote controllers can be paired with one processor unit. Do as follows to set up Bluetooth® pairing.

**Note:** To reset the settings on the remote controller, you need to cancel the pairing first. See subsection 6.5.2.

1. Insert the Bluetooth® adapter to the USB port on the processor unit.
2. Open the menu.
3. Select the [System] tab from the main menu.
4. Select the [InitSetting] from the sub menu.
5. Select [Connect remote control]. The following message appears.

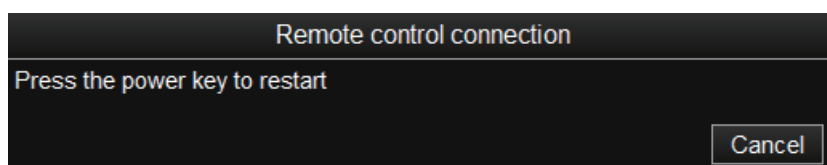

**Note:** If four remote controllers have already been paired with the processor unit, the message "Maximum number of remote controls registered. Disconnect a registered remote control, then try again." appears. In this case, delete the unnecessary pair.

6. Turn the power of the equipment off, and turn it on again. The following message appears.

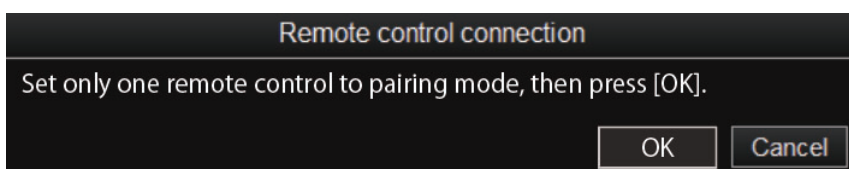

7. Long-press the power switch key (⏻) on the remote controller to turn it on. When the power is supplied, the LED light next to the power switch key flashes twice in green. If not paired with a processor unit, the pairing mode is automatically activated.
8. Click [OK]. If any non-paired remote controller is detected, the following window appears.





9. Select the remote controller to be paired, and click [OK].

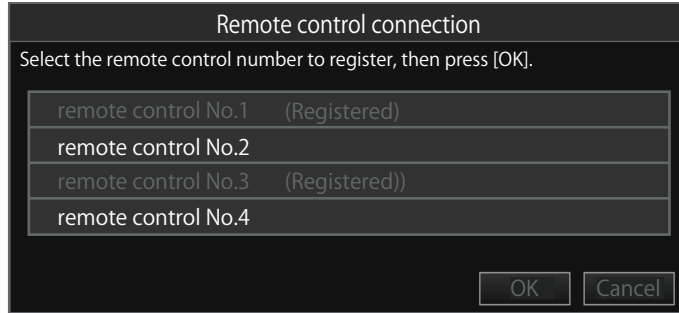

10. Select the remote controller from No.1 to No.4, then click [OK].

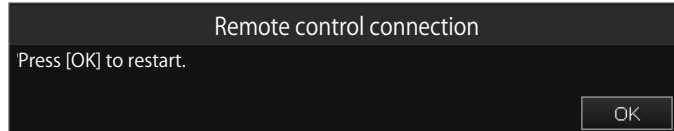

11. Click [OK] to restart the system.

12. Attach the label, on which the remote controller number is printed (local supply), to the remote controller. If you have more than one processor unit and remote controller, make sure to classify the correct pairs.

**Note:** Before replacing the Bluetooth® adapter with a new one, do as follows.

- 1) With the current Bluetooth® adapter inserted to the USB port, cancel pairing with all remote controllers.
- 2) Insert the new Bluetooth® adapter, and set up the pairing again.

**Remote control status**

When [Remote control status] under the [InitSetting] menu is set to [ON], the remote controller status is displayed at the top right corner of the sonar display. The different icon colors indicate the remote controller status as shown below. No icon indicates that there is no remote controller connected.

Icon color	Description
Background color	No remote control connection • The processor unit or remote controller is turned OFF. • Out of wireless LAN communication area.
Green	With remote control connection • The processor unit and remote controller are turned ON.
Red	With remote control connection. Battery replacement is required.

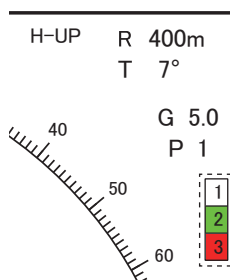

- No.1: No remote control connection
- No.2: With remote control connection (Battery normal)
- No.3: With remote control connection (Battery needs replacement)

### 6.5.2 How to cancel pairing

To undo pairing, do as follows.

1. Open the menu.
2. Select the [System] tab from the main menu.
3. Select the [InitSetting] from the sub menu.
4. Select [Disconnect remote control].

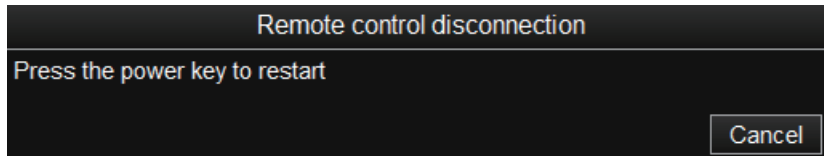

5. Turn the power of the equipment off, and turn it on again. If any applicable remote controller is detected, the following window appears.

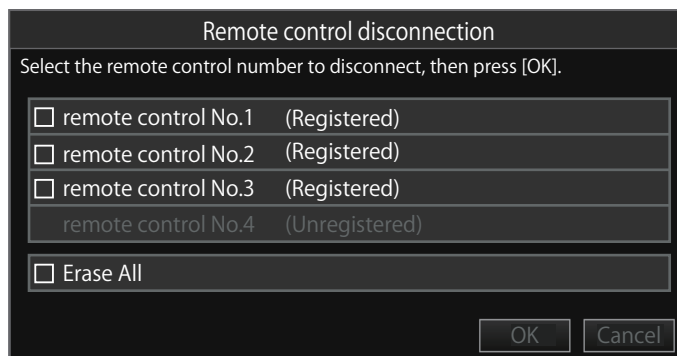

6. Select the remote controller to cancel pairing, then click [OK]. You can select one or more remote controllers.

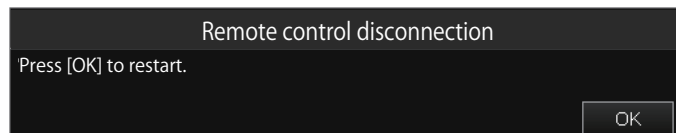

**Note:** To cancel pairing with all remote controllers, select [Erase All].

7. Click [OK] to restart the system.

### 6.5.3 How to change the functions assigned to the function keys

You can change the functions assigned to the function keys (**A** to **E**) on the remote controller. The same functions apply to the function keys of all remote controllers (No.1 to No.4).

1. Open the menu.
2. Select the [System] tab from the main menu.
3. Select the [InitSetting] tab from the sub menu.
4. Select one from [Set remote control key (A)] to [Set remote control key (E)].
5. From the drop-down list, select the function to assign to the function key.

**Note:** If you register the raise/lower movement functions ([Retract] or [Full Protrude]), assign them vertically (columns A to C and D to E) rather than

horizontally, for safety reasons. For example, if you assign [Retract] to the **B** key, assign [Full Protrude] to the **D** or **E** key.

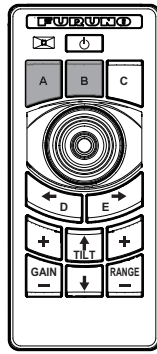

Side-by-side keys  
Not recommended

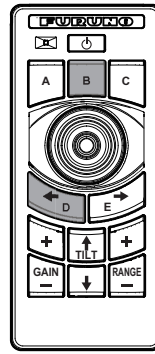

Keys in separate rows  
Recommended

When [Retract] or [Full-Protrude] is selected, the following message appears. Click [OK] to confirm the message.

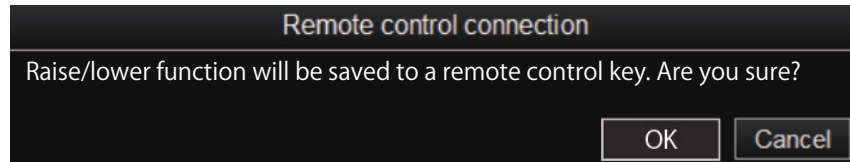

6. Close the menu.

#### **When raise/lower function is assigned:**

When a raise/lower function ([Retract] / [Full-Protrude]) is assigned to the keys, double-press the applicable key to perform the operation. Single-press does not work, and the message "To raise/lower the transducer from the remote control, double-click the key." appears.

6

### **6.5.4 How to check currently assigned functions**

You can check currently assigned functions by the following steps.

1. Open the menu.
2. Select the [System] tab from the main menu.
3. Select the [InitSetting] tab from the sub menu.
4. Select [Registered remote control list]. A list appears.

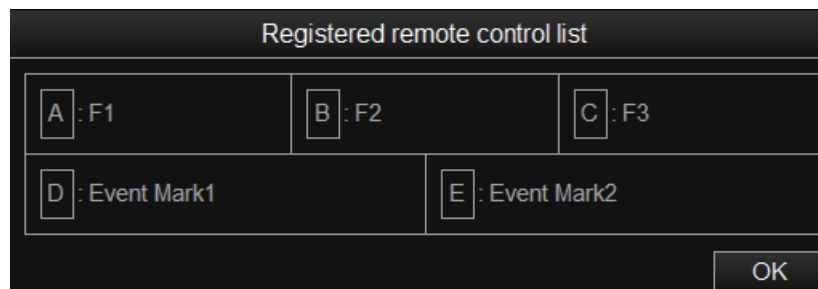

5. Click [OK].
6. Close the menu.

## 6. HOW TO CUSTOMIZE THE SONAR

This page is intentionally left blank.

# 7. DATA RECORD/PLAY

## 7.1 How to Specify Where to Save Still and Motion Images

Select the location where to save still images and video files.

1. Open the menu.
2. Select the [System] tab from the main menu.
3. Select the [Record] tab from the sub menu.

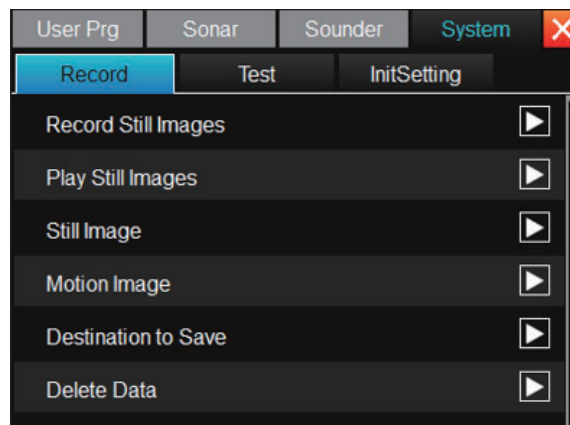

4. Select [Destination to Save]. The below window appears. D drive is set as the destination in the factory default setting.

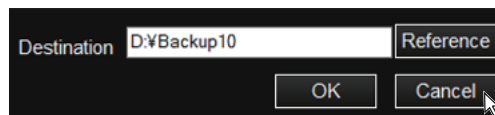

5. Click [Reference] button on the destination setting window.

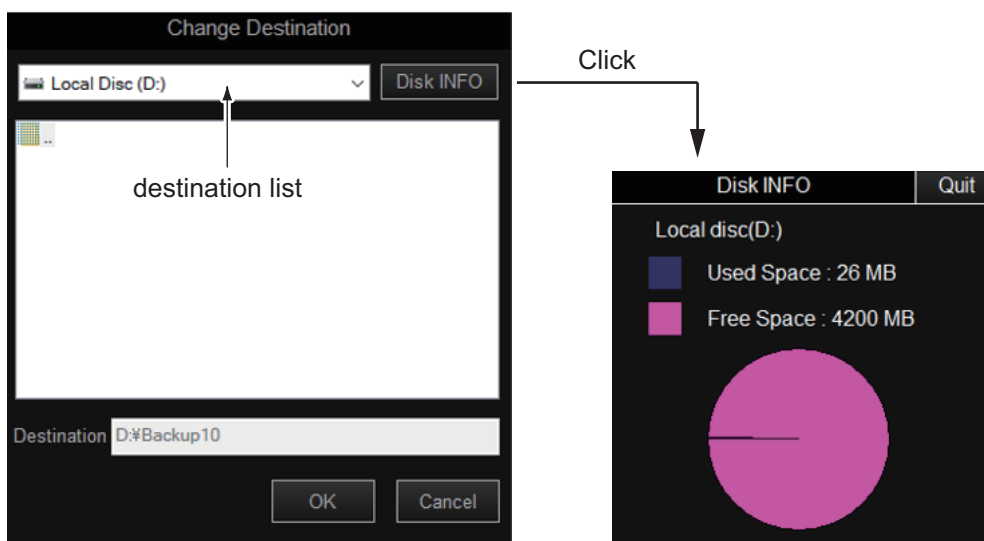

You can check the used space and the free space of the currently selected disk.

**Note:** The capacity of D drive may change.

## 7. DATA RECORD/PLAY

6. Select the storage location from the destination list.

**Note 1:** To set an external storage device (USB device) as the destination, click [∨] on the right end of the destination list and change the destination from the [Local Disc (D:)].

**Note 2:** The external recording medium drive differs depending on whether the SSD assembly OP10-61 (optional) is installed in the control unit.

- Without SSD: The external storage device is in drive E or later.
- With SSD: The SSD is in drive E and the external storage media is in drive F or later.

7. Click [OK] and close the menu.

## 7.2 How to Save a Still Image

You can save the images shown on the display as a still image. Each image requires an estimated memory space of 200 kB. However, the image file size varies depending on the image contents.

The still images can be saved to the location specified in section 7.1 along with the setting data. The file name is automatically assigned to the saved data.

- Still image: yyyy\_mm\_dd\_hh\_mm\_ss\_comment\*.jpg
- Setting data: RECORD\_yyyy\_mm\_dd\_hh\_mm\_ss\_comment\*.dat

\*: Shown only when entered.

**Note:** When there is not enough space on the drive to store more images (remaining space is approx. 10% or less), the warning message "Disk space is insufficient. Delete unnecessary file." appears. Click [Delete Data], and delete unnecessary files referring to section 7.6, and try again to save the still image.

### Saving from [Still Image]

1. Open the menu.
2. Select the [System] tab from the main menu.
3. Select the [Record] tab from the sub menu.
4. Select [Still Image].

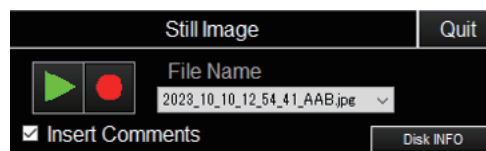

5. To add a comment to the still image, put a check mark on the [Insert Comments].
6. Select the red button [●] on the [Still Image] window to save the image.  
The picture at the moment the button is pressed is shown on the display (preview image\*). If the check mark is put in the step 5 above, a software keyboard also appears to enter a comment.  
\*: If the check mark is not put on [Insert Comment], then the image shown after the button was pressed disappears in approx. four seconds.
7. Enter a comment (max. 20 characters). See page 1-8 for how to enter characters.

8. After entering the comment, click [Enter]. The software keyboard and the preview image disappear from the display.
9. To finish, select [Quit] at the top of the window.

#### **Saving from [Record Still Images]**

1. Open the menu.
2. Select the [System] tab from the main menu.
3. Select the [Record ] tab from the sub menu.
4. Select [Record Still Images].  
The picture at the moment the button is pressed is shown on the display (preview image). If the check mark is put in [Insert Comments], a software keyboard also appears to enter a comment.
5. Enter a comment (max. 20 characters). See page 1-8 for how to enter characters.
6. After entering the comment, click [Enter]. The software keyboard and the preview image disappear from the display.
7. Close the menu.

**Note:** In the default arrangement, you can save the displayed image by pressing the **F1** key.

## **7.3 How to Show the Saved Still Image**

There are two ways to display the saved still images.

- Show the latest still image.
- Show a still image from the file name list.

#### **Display the latest still image**

1. Open the menu.
2. Select the [System] tab from the main menu.
3. Select the [Record] tab from the sub menu.

## 7. DATA RECORD/PLAY

4. Select [Play Still Images].  
The latest still image is shown on the display.

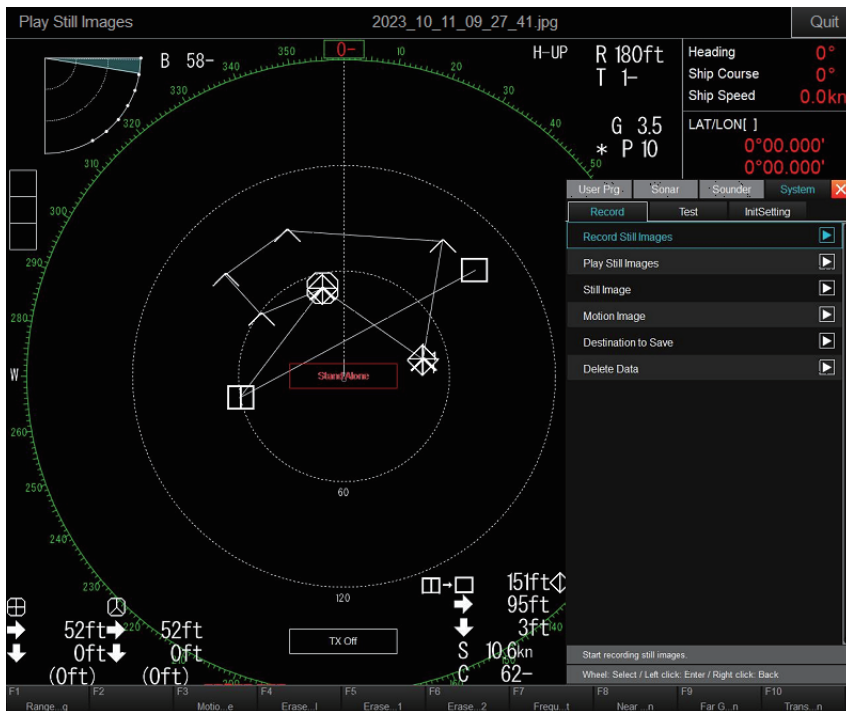

The window can be resized or moved by drag and drop. Also, you can zoom in or out using the wheel knob, and resize the window by drag and drop within the window if the still image is not fully displayed.

5. Click [Quit] on the [Play Still Image] window to close the menu.

**Note 1:** In the default arrangement, you can play the latest saved still image by pressing the **F2** key.

**Note 2:** If the still image is not fully displayed, resize the window.

### Display the still image selected from the play list

1. Open the menu.
2. Select the [System] tab from the main menu.
3. Select the [Record ] tab from the sub menu.
4. Select [Still Image].
5. Select the file to display.
6. Click the green arrow button indicated on the window. The selected file is shown on the display. A maximum of eight images can be shown at once. When the 9th image is selected, the oldest image is automatically deleted.
7. Select [Quite] on the [Play Still Images].
8. Select [Quite] on the [Still Image] window.

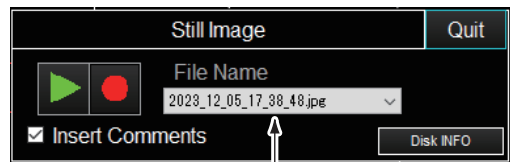





## 7.4 How to Save Motion Images

The image shown on the display can be saved as a motion image.

**Note:** When saving motion images, it is recommended to save the images to an external hard drive, connected to the USB port on the processor unit.

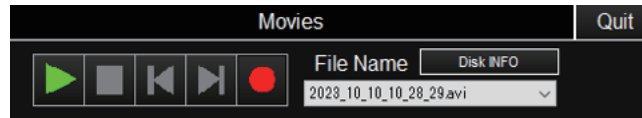
1. Open the menu.
2. Select the [System] tab from the main menu.
3. Select the [Record] tab from the sub menu.
4. Select [Motion Image].



5. Click the red button [  ] on the window to save the image.
6. To stop saving, click the flashing red button [  ] again. The file is saved on the location specified in section 7.1. The file name is automatically assigned in the following format.

- yyyy\_mm\_dd\_hh\_mm\_ss.avi

**Note:** When the file size of the motion image is greater than 2 GB, the image is saved in segments. Each segment is approx. 2 GB in size. In this case, the segment number appears after the "seconds" indication. For example, yyyy\_mm\_dd\_hh\_mm\_ss\_1.avi, yyyy\_mm\_dd\_hh\_mm\_ss\_2.avi, etc. The file containing 10 to 30 minute motion file occupies 2 GB, depending on the image contents.

7. Select [Quit] to close the window.

**Note 1:** In the default arrangement, the motion image window can be opened by pressing the **F3** key.

**Note 2:** When there is not enough space on the drive to store more images (remaining space is approx. 10% or less), the warning message "Disk space is insufficient. Delete unnecessary file." appears. Click [Delete Data], and delete unnecessary files referring to section 7.6, and try again to save the motion image.

## 7.5 How to Play Back Motion Images

You can play back motion images as follows:

1. Open the menu.
2. Select the [System] tab from the main menu.
3. Select the [Record] tab from the sub menu.
4. Select [Motion Image].

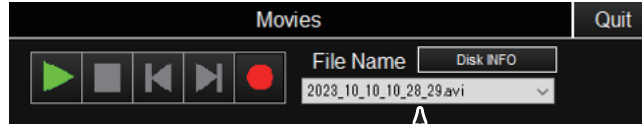

File name list

5. Select the motion image file to play.
6. Click the green arrow button . The file selected in step 5 will be played.

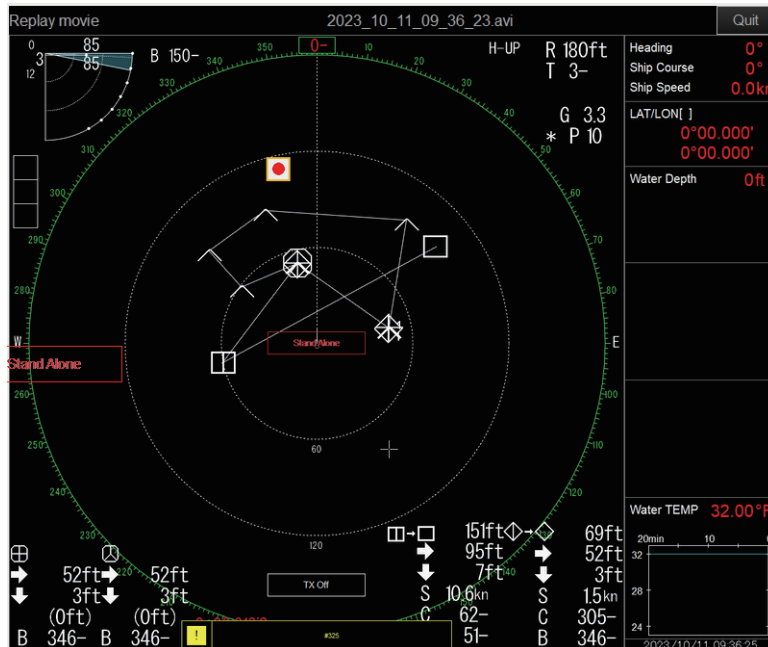

The window can be resized or moved by drag and drop. You can also pause, fast-forward, or rewind the motion image on the display.

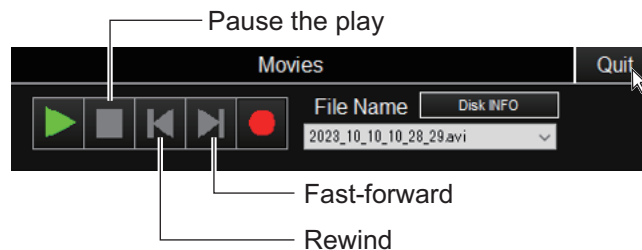

7. Select [Quit] on the [Play Movies] window.
8. Select [Quit] on the [Movies] window.

## 7.6 How to Delete Files

You can delete unnecessary files (still images, motion images, setting data, etc.) as indicated below.

1. Open the menu.
2. Select the [System] tab from the main menu.
3. Select the [Record] tab from the sub menu.
4. Select [Delete Data]. The window below appears.

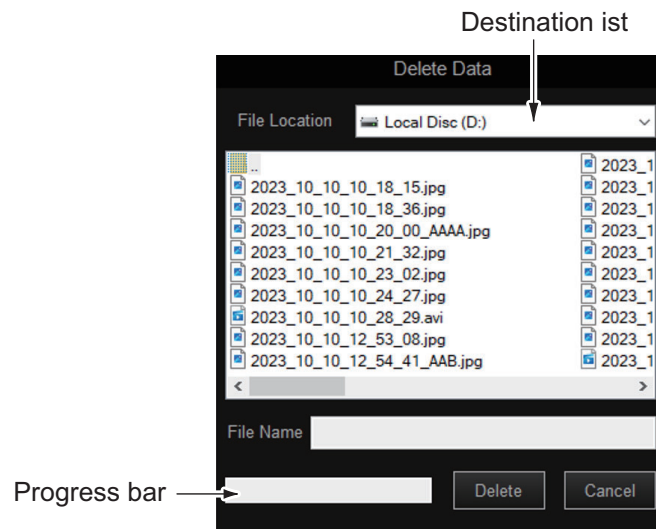

5. Select the file to delete. The selected file is shown in the [File Name] column.
6. Click [Delete]. The message "Are you sure to delete?" appears.
7. Click [OK]. The data selected in step 5 is deleted. The deletion status can be checked on the progress bar.
8. To close the menu, click [Cancel] on the [Delete Data] window.
9. Close the menu.

7. DATA RECORD/PLAY

This page is intentionally left blank.

# 8. HOW TO INTERPRET THE DISPLAY

## 8.1 Bottom Echo

When the tilt angle is changed, the bottom echo appears on the screen. When the tilt angle is decreased, the bottom trace becomes wider and weaker. By observing the bottom condition on the screen, the skipper can prevent the net from being damaged by a reef or a shipwreck.

(A) Flat bottom  
Tilt angle: 10° to 15°

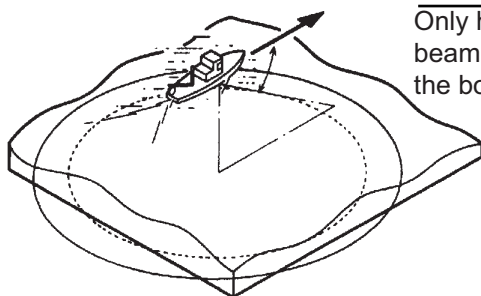

Decreased tilt angle  
Only half of vertical  
beam width captures  
the bottom.

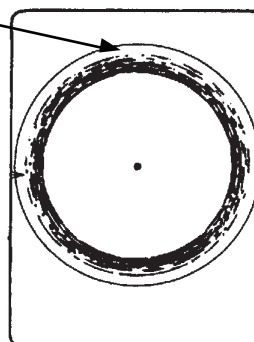

(B) Flat bottom  
Tilt angle: 20° or more

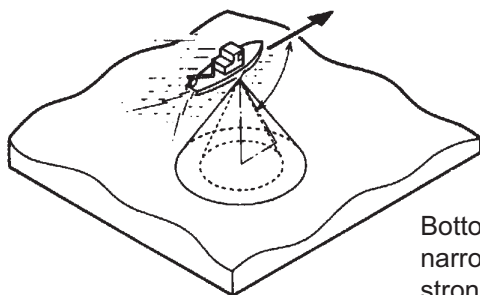

Bottom is displayed  
narrower and in  
stronger colors when  
compared to (A).

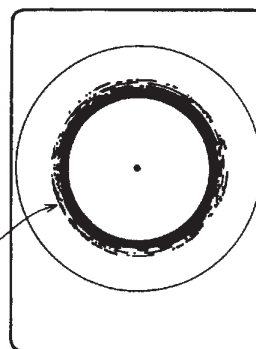

(C) Sloping bottom  
Tilt angle: 20° or more

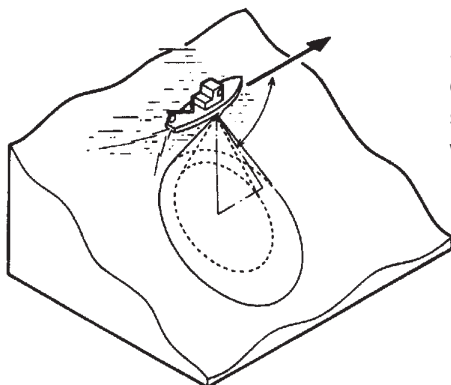

Shallow bottom is  
displayed in a  
strong color and  
with a short tail.

Bottom

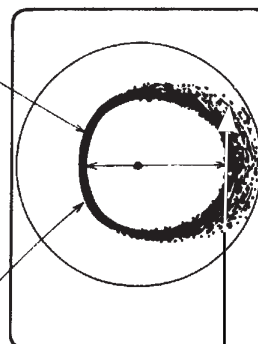

The deeper, sloping  
bottom echo is displayed  
in a weak color and with  
a long tail.

## 8.2 School of Fish

A school of fish appears as a mass of echoes. The color of the mass shows the density. To know the distribution and center point of a school of fish, choose several different tilt angles.

(A) Sea surface fish  
Tilt angle: 0° to 10°

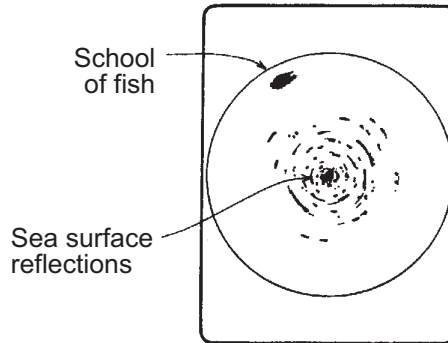
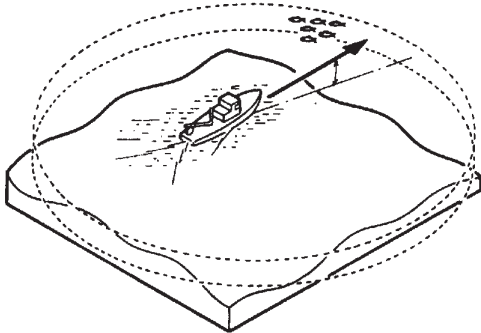

Bottom echo not displayed because of decreased tilt angle. Sea surface reflections are present.

(B) Midwater, bottom fish Tilt angle: 30° or more  
Fish echo which appears before bottom can be detected.

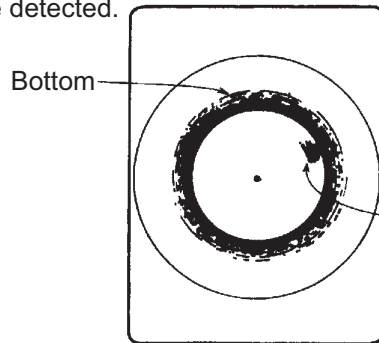
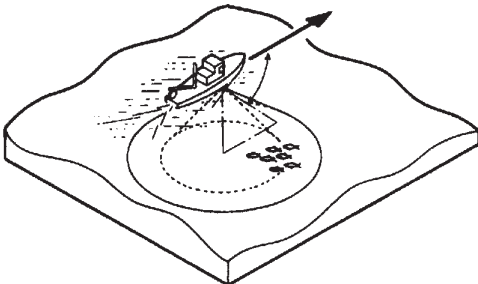

School of fish  
Large midwater school of fish is present.

Tilt angle: 0° to 20°  
Fish echo which appears together with or after bottom can be detected.

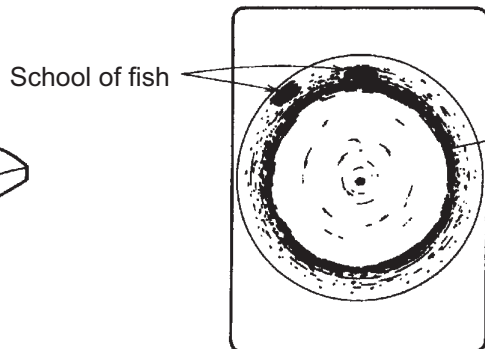
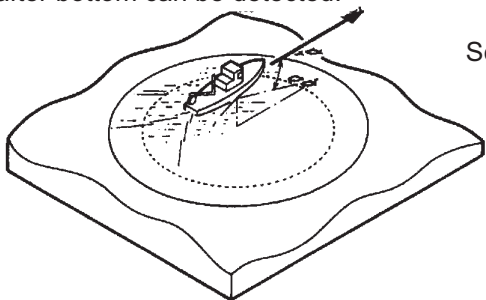

To search bottom fish, use a narrow tilt angle so the bottom echo will be weak, enabling you to see bottom fish echoes.

### 8.3 Sea Surface Reflections

To reduce sea surface reflections, set the tilt angle to 4° or more, so that the upper edge of the sonar beam does not hit sea surface, or adjust the near gain. When the sonar is used with a narrow tilt angle, the sea surface reflections cover a large area as illustrated below.

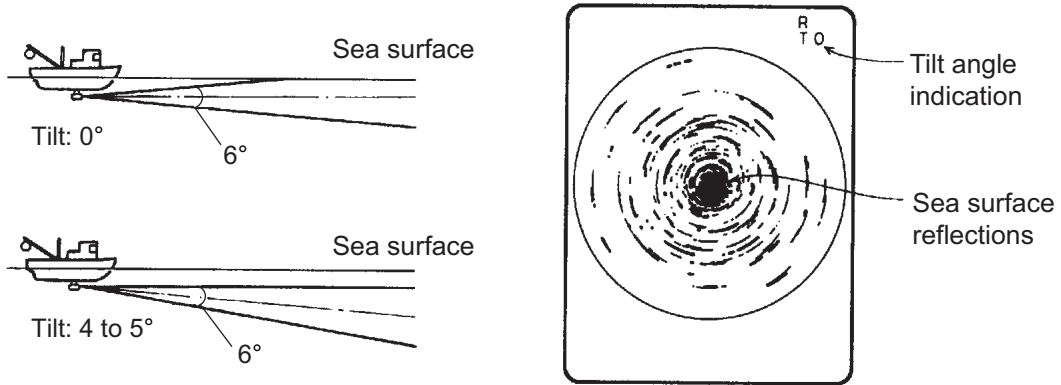

### 8.4 Tracks

A track produced by own ship or another ship can be a strong reflecting object when the sonar is used with a narrow tilt angle. As the track appears on the screen as a thick continuous line, it can be easily distinguished from a school of fish. On the other hand, the track contains a lot of air bubbles which attenuate ultrasonic energy, making it often difficult to sound beyond the track.

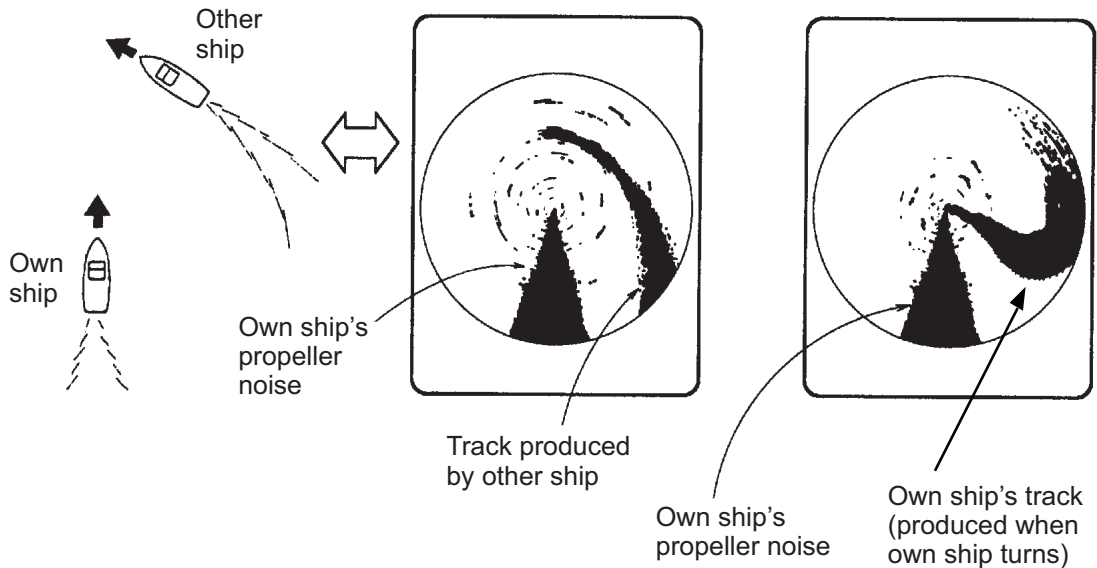

## 8.5 False Echo by Sidelobe

An ultrasonic wave is emitted only in the direction set by the **TILT** lever. However, in practice, there are some emissions outside the main beam, called sidelobes. Energy of the sidelobe is fairly weak, but when the sonar is used in comparatively shallow water with a hard and rocky bottom, strong target signals may be detected by the sidelobe. There are represented on the screen as a false echo as shown below.

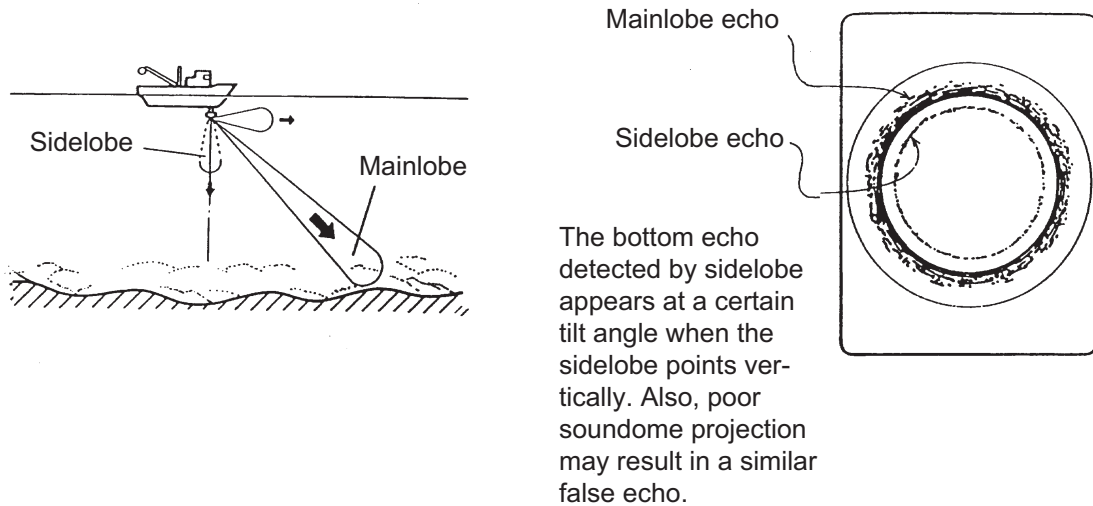

## 8.6 Noise and Interference

If the fishing ground is crowded with many fishing boats, the sonar is subject to interference from ultrasonic equipment such as an echo sounder, sonar, etc. on board other boats as well as those on board own ship. For instance, interference from the sonar operated on board other boats will appear as a ring as shown in (A). This interference can be suppressed by properly changing the TX cycle. Also, the noise from marine life appears as shown in (B). This interference can be suppressed by the interference rejector from the [User Prg] - [Interference Rejector 1] menu.

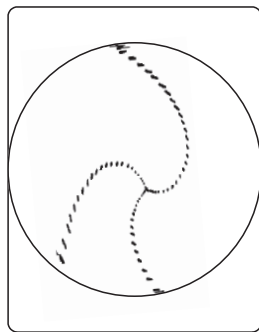

(A) Interference from other sonar

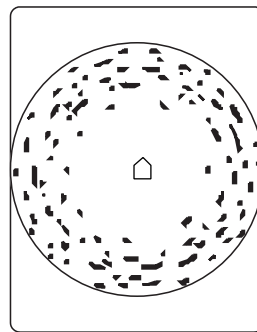

(C) Marine life noise



# 9. OTHER SETTINGS

This chapter describes setting details for each menu.

## 9.1 [USER PROG] Menu

The [USER PROG] menu provides the settings related to the sonar image.



Menu item	Description
TX Interval	Sets the transmission interval (see subsection 2.4.4).
TX Pulse Length	Sets the transmission pulse length (see subsection 2.2.2).
Transmission power	Sets the transmission power (see section 2.3).
Frequency Shift	Sets the transmission frequency (see subsection 2.4.5).
Horizontal beam width	Sets horizontal beam width (see section 2.5).
Vertical beam width	Sets vertical beam width (see section 2.5).
Near Gain	Sets the near gain (section 2.1).
Far Gain	Sets the far gain (see section 2.1).
AGC Near	Sets AGC near (see subsection 2.2.1).
AGC Far	Sets AGC far (see subsection 2.2.1).
Noise Suppression	Reduces the unwanted echoes (see subsection 2.2.3).
Noise Suppression (SHIP)	
Nose Limiter	Rejects noise (see subsection 2.4.3).
Signal Level	Removes weak echoes (see section 2.6).

Menu item	Description
Color Setting	Changes the echo colors from the Color Setting window. See below "How to change color setting".
Color Curve Setting	Changes the echo color curve setting from the Color Curve Setting. See "How to change the color curve setting" on page 9-4.
Echo Average	Adjusts the echo average (see subsection 2.4.6).
Interference Rejector 1	Rejects noise (see subsection 2.4.2).
Interference Rejector 2	
Smooth Echo Range	Sets the level to smooth the image in range direction.
Smooth Echo Circular	Sets the level to smooth the image in circular direction.
Register User prog	Registers user programs (see subsection 6.2.2).

**How to change the color setting**

The ten different display colors can be set to each user program number from P1 to P10. Do the following to set the color.

1. Select [Color Setting] to show the [Display color setting] window.

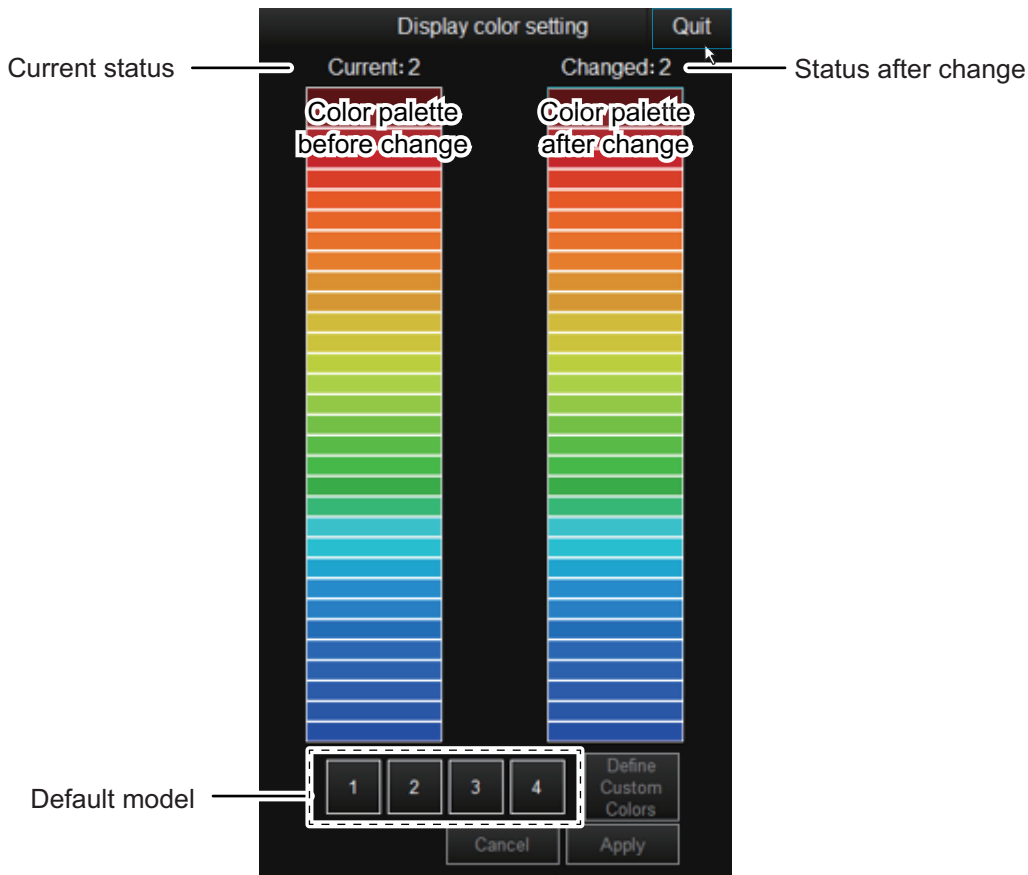

2. Select the color pattern from the four default models. You can check the color patterns by clicking the default model numbers. The status shown at the top of the window changes.
  - [1] to [4]: Default model is selected.
  - [Customized]: Color pattern other than a default model is selected.

3. Select the color on the [Changed] palette you want to change.

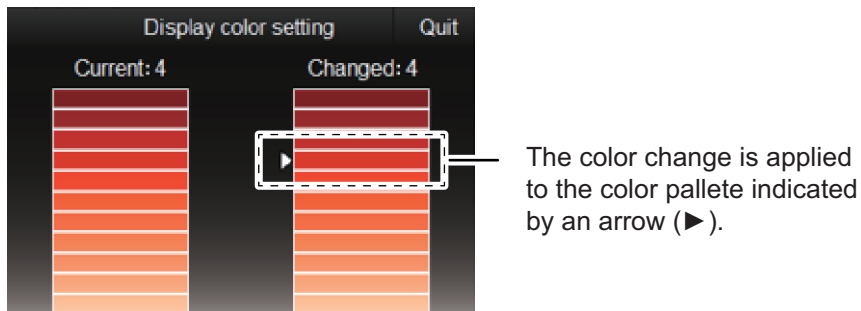

4. Set the display color from one of the following methods.

#### **Select from the 32-color palette**

Select the color from the [Current] palette, then the color selected is applied to where indicated with an arrow (▶). The status display changes to [Original].

#### **Create a new color**

You can also create a desired color.

- 1) On the [Display color setting] window, select [Define custom colors] to show the color creation window below.

1. Click the desired color.

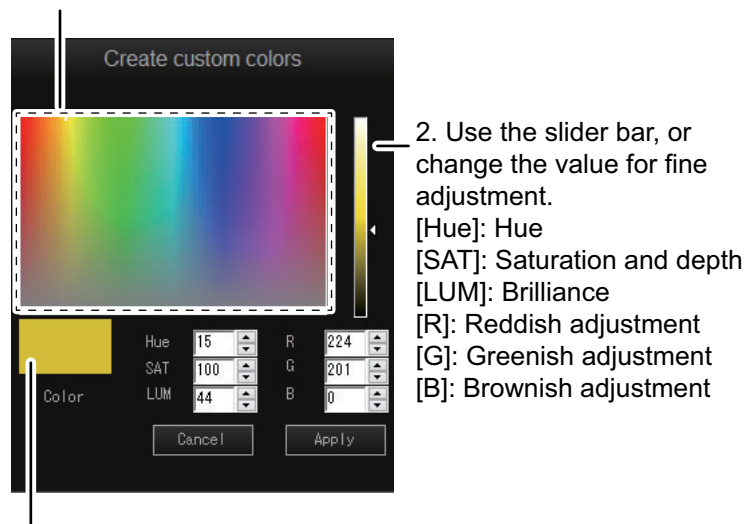

Color preview

- 2) Select the color by clicking the desired color, or create the color by adjusting the slider bar or the each coloring value. The color created here is applied to the color marked with an arrow (▶) on the [Changed] palette (after change palette). The status display changes to [Original].
- 3) Click [Apply] to finish.
5. Repeat steps 3 and 4 above to change other colors.
6. After adjusting all the colors, click [Apply] on the [Display color setting] window.
7. Click [Quit] on the [Display color setting] window to finish.

**How to change the color curve setting**

The ten different color curves can be set to each user program number from P1 to P10. Do as follows to set a color curve.

1. Select [Color Curve Setting] to show the [Color curve setting] window.

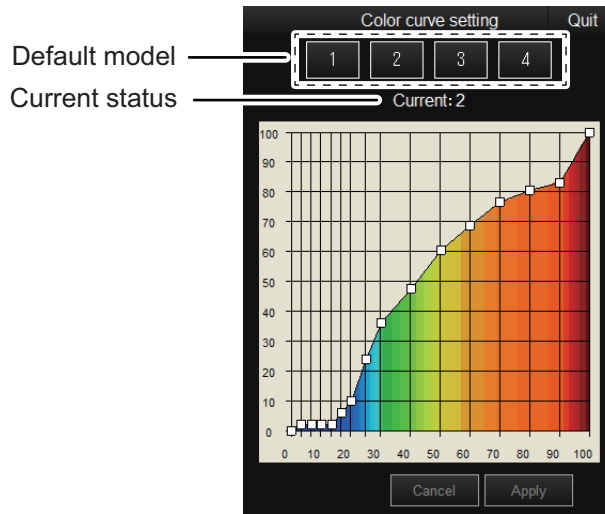

2. From the four default models, select the color curve to use for echoes based on echo strength. Click a default model from [1] to [4] to determine the color curve for response strength. The current status is indicated as follows.
  - [1] to [4]: Default model is selected.
  - [Customized]: Color curve other than a default model is selected.
3. To adjust the color curve, place the cursor at the point desired, and click on it. On the horizontal axis, input level relative value is shown in the range from 0 to 100%. The setting range for input level is 0 to 100% in 14 points, and output level is 0 to 100% in any value. The points you can input are shown with a square, and the current status changes to [Customized].
4. Click [Apply].
5. Click [Quit] on the [Color curve setting] window to finish.

## 9.2 [Sonar] Menu

### 9.2.1 [Sonar] menu

The [Sonar] menu provides the settings related to display and functions in the horizontal single display mode.

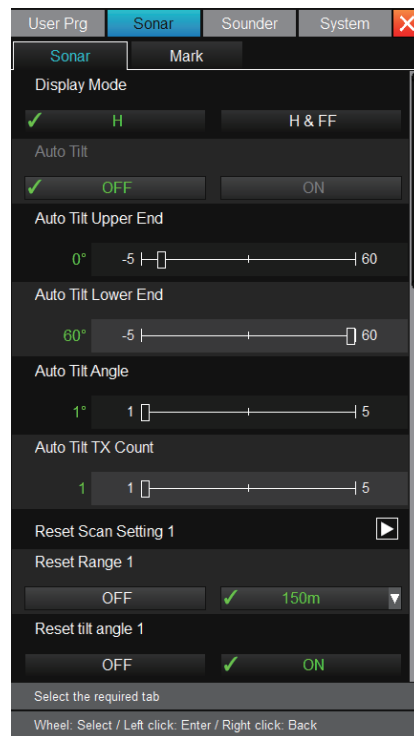

Menu item	Description
Display Mode	Selects the display mode (see subsection 1.3.5).
Auto Tilt	Turns auto tilt ON or OFF (see subsection 1.4.2). This function is disabled while retracting the transducer, or the target lock is active.
Auto Tilt Upper End	Sets the upper end of the auto tilt range (see subsection 1.4.2).
Auto Tilt Lower End	Sets the lower end of the auto tilt range (see subsection 1.4.2).
Auto Tilt Angle	Sets the angle for the auto tilt (see subsection 1.4.2).
Auto Tilt TX Count	Sets the transmission count for auto tilt (see subsection 1.4.2).
Reset Scan Setting 1	Resets the Scan Setting 1 (see subsection 6.3.2)
Reset Range 1 Reset Tilt angle 1 Reset Sensitivity 1	Sets Range 1, Tilt angle 1, or Sensitivity 1 to reset (see subsection 6.3.1)
Reset Scan Setting 2	Resets the Scan Setting 2 (see subsection 6.3.2).
Reset Range 2 Reset Tilt angle 2 Reset Sensitivity 2	Sets Range 2, Tilt angle 2, or Sensitivity 2 to reset (see subsection 6.3.1).
Net Course Mark	Shows or hides the net course mark (see section 3.9).
Fish Alarm	Turns the fish alarm ON or OFF (subsection 3.3.1).
Alarm Level	Sets the color level for the fish alarm (subsection 3.3.2).
Alarm Zone	Sets the fish alarm zone, and available when [Fish Alarm] is [ON] (subsection 3.3.1).
R/B Audio (F registration)	Assigns the range and bearing function to the function key (subsection 3.2.2).

## 9. OTHER SETTINGS

Menu item	Description
Audio	Turns the audio ON or OFF (see subsection 3.2.1).
Audio Gain	Adjusts the audio volume (subsection 3.2.3).
Ship Speed Alarm	Sounds the buzzer when the ship exceeds the predetermined speed under the following conditions. This function is [ON] in the default setting. <ul style="list-style-type: none"> <li>• When the transducer is lowered (protruded): 20 kn</li> <li>• While the transducer is being raised/lowered: 18 kn</li> </ul>
Auto Retraction	Sets auto retraction ON or OFF. With this function ON, the transducer is automatically raised and retracted when ship exceeds the predetermined speed. <ul style="list-style-type: none"> <li>• [OFF]: Disables the auto retraction.</li> <li>• [ON]: Set the speed to use. When the ship exceed this predetermined speed, the transducer is automatically raised/retracted. Also, the buzzer sounds if exceeds predetermined speed while lowering the transducer.</li> </ul> <p><b>Note:</b> External input required.</p>

### 9.2.2 [Mark] menu

The [Mark] menu provides the settings related to fish estimate marks and net shoot marks, as well as erasure those marks.

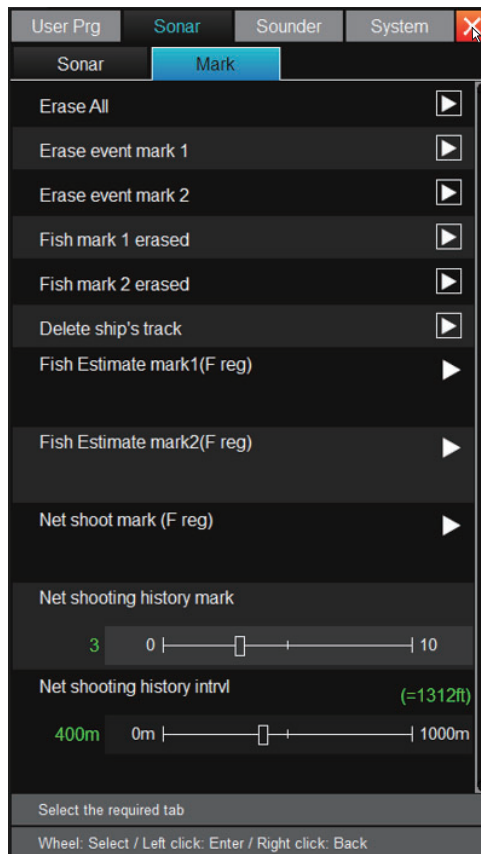

Menu item	Description
Erase All	Erases all event marks (1/2) and fish marks (1/2). The same operation as long-pressing <b>DELETE MARK</b> key on the control unit.
Erase event mark 1 Erase event mark 2	Erases the oldest event mark 1 or 2 (see subsection 3.6.2).
Fish mark 1 erased Fish mark 2 erased	Erases the oldest fish mark 1 or 2 (see subsection 3.4.2).

Menu item	Description
Delete ship's track	Deletes approx. 10% of the oldest ship's track.
Fish Estimate Mark 1 (F reg) Fish Estimate Mark 2 (F reg)	Assigns fish estimate mark 1 and 2 functions to a function key (subsection 3.7.1).
Net shoot mark (F reg)	Assigns net shoot mark function to a function key (see subsection 3.10.2).
Net shooting history mark Net shooting history intvl	Set the number of marks to display, and its display intervals (see subsection 3.10.1). When the net shooting history mark is entered, this function is disabled.

## 9.3 [Sounder] Menu

The [Sounder] menu provides the settings related to fish finder images. See chapter 4 for details of each menu.

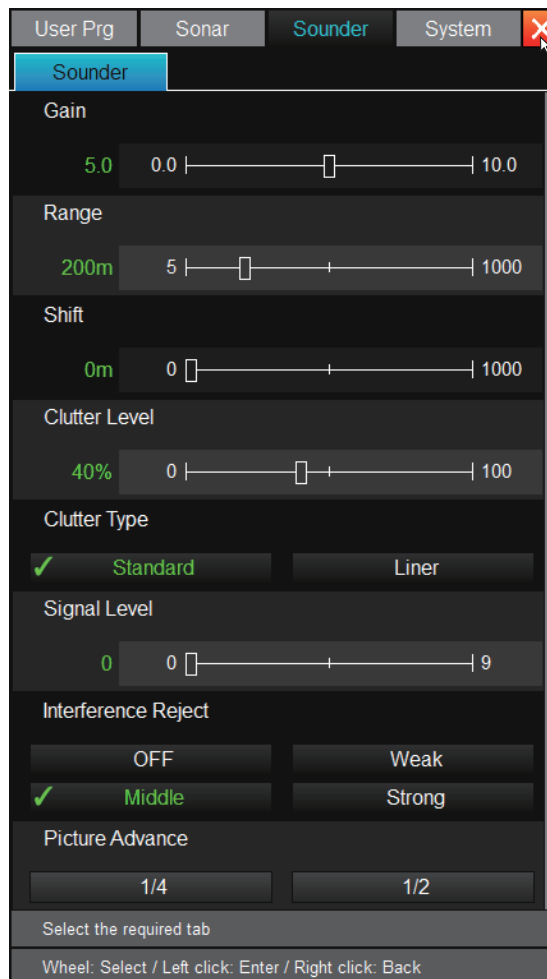

## 9.4 [System] Menu

### 9.4.1 [Record] menu

The [Record] menu provides the settings related to still and motion images. See chapter 7 for details of each menu.

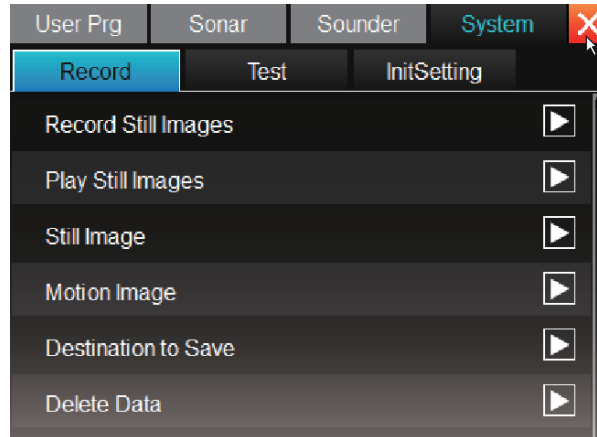

### 9.4.2 [Test] menu

With the [Test] menu, you can perform diagnostic tests to confirm that the equipment is working properly. See section 10.10 for details of each menu.

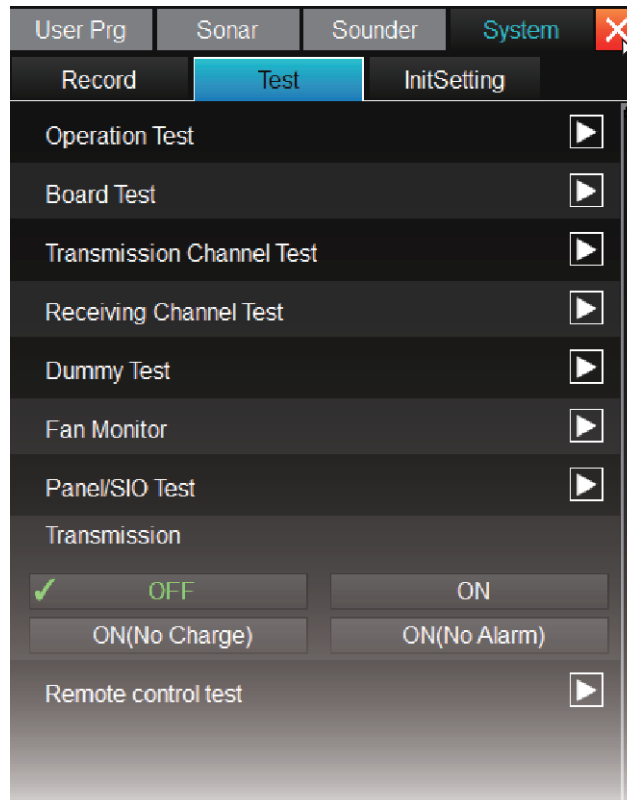



### 9.4.3 [InitSetting] menu

The [InitSetting] menu provides the settings related to the remote controller (option), distance unit, and sound volumes.

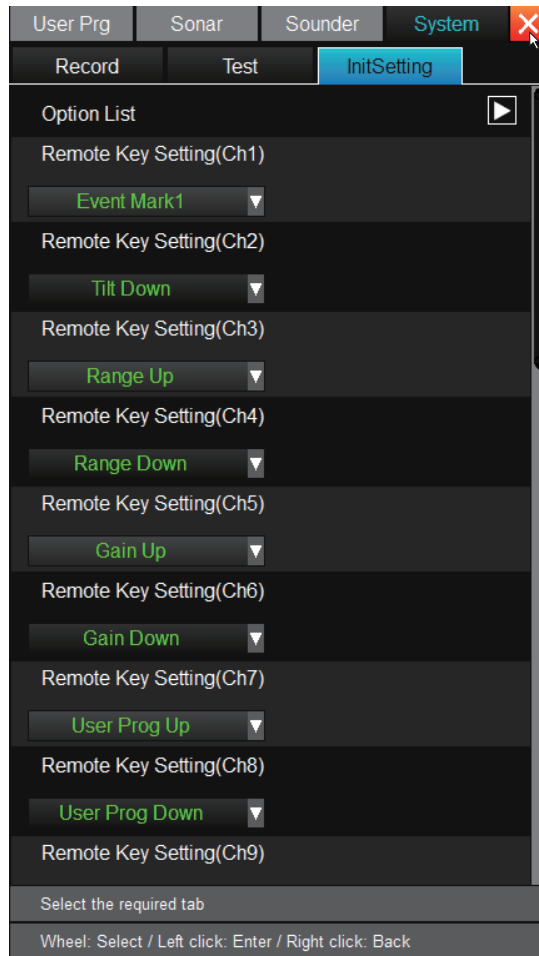

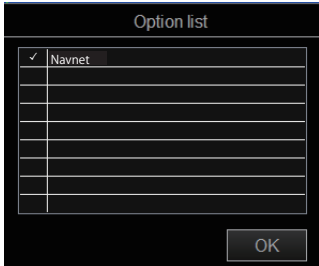
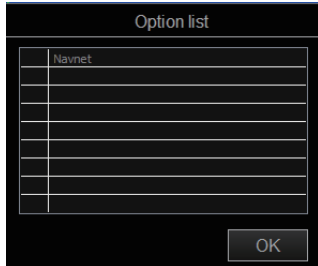
Menu item	Description
[Option List]	<p>Displays a list of option functions.</p> <div style="display: flex; justify-content: space-around; align-items: center;"> <div style="text-align: center;">  <p>Valid</p> </div> <div style="text-align: center;">  <p>Invalid (grayout)</p> </div> </div>
[Remote Key Setting 1 (Ch1)] to [Remote Key Setting 1 (Ch10)]	Assigns a function to each key of the remote controller FSV-854-MK2 (see section 6.4).
[Connect remote control]	Sets up Bluetooth® pairing with the remote controller SCU-001 (see subsection 6.5.1).
[Disconnect remote control]	Cancels Bluetooth® pairing with the remote controller SCU-001 (see subsection 6.5.2).



9. OTHER SETTINGS

Menu item	Description
[Set remote control key (A)] to [Set remote control (E)]	Assigns a function to the function key of the remote controller SCU-001 (see subsection 6.5.3).
[Registered remote control list]	Confirms the functions assigned to the function keys of the remote controller SCU-001 (see subsection 6.5.4).
[Remote control status]	Shows or hides the remote controller status (SCU-001) at the top right corner of the sonar display (see page 6-9).
[Distance Unit (Sonar)]	Selects the distance unit to be displayed on the sonar display, text/data display area, and menus (other than [Sounder] menu).
[Distance Unit (Fish finder)]	Sets the distance unit to be displayed on the fish finder display and the [Sounder] menu.
[Trackball Speed]	Sets the tracking speed of the trackball within the menu.
[Dimmer]	Adjusts the brightness of the control panel (see subsection 1.3.4).
[Key Beep Volume]	Adjusts the volume of beep sound. [0] is OFF.
[Speaker Volume]	Adjusts the speaker volume. [0] is mute.

# 10. MAINTENANCE

---

This chapter provides maintenance and troubleshooting procedures for the operator.

<p> <b>WARNING</b></p> <p> <b>ELECTRICAL SHOCK HAZARD</b> Do not open the equipment.</p> <p>This equipment uses high voltage that can cause electrical shock. Only qualified persons are allowed to work inside the equipment.</p>	<p><b>NOTICE</b></p> <p>Do not apply paint, anti-corrosive sealant or contact spray to plastic parts or equipment coating.</p> <p>Those items contain products that can damage plastic parts and equipment coating.</p>
--	---

## 10.1 Periodic Maintenance

Regular maintenance is important for keeping the equipment in good working order. check the following points on a regular basis.

**Note:** Always turn off the breaker of the hull unit when carrying out the hull unit maintenance. If the breaker is turned on, the transducer automatically rises to the upper limit position, which may cause injury.

- Check the cables for wear, tear, and damage.
- Check that the connectors are securely connected, and free of corrosion.
- Check the grounding terminal for corrosion and damage. Also check that the equipment is correctly grounded.
- Have a qualified technician check the hull unit approximately once per year. See section 10.12.

### **Cleaning the equipment cabinet**

Check the equipment and each unit for dust and dirt. If any dust or dirt is observed, use a soft, dry cloth to clean them. Do not use the chemical cleaners to clean the equipment. They can remove paint and markings.

## 10.2 Hull Unit Maintenance

Carry out the hull unit maintenance shown in the below figure.

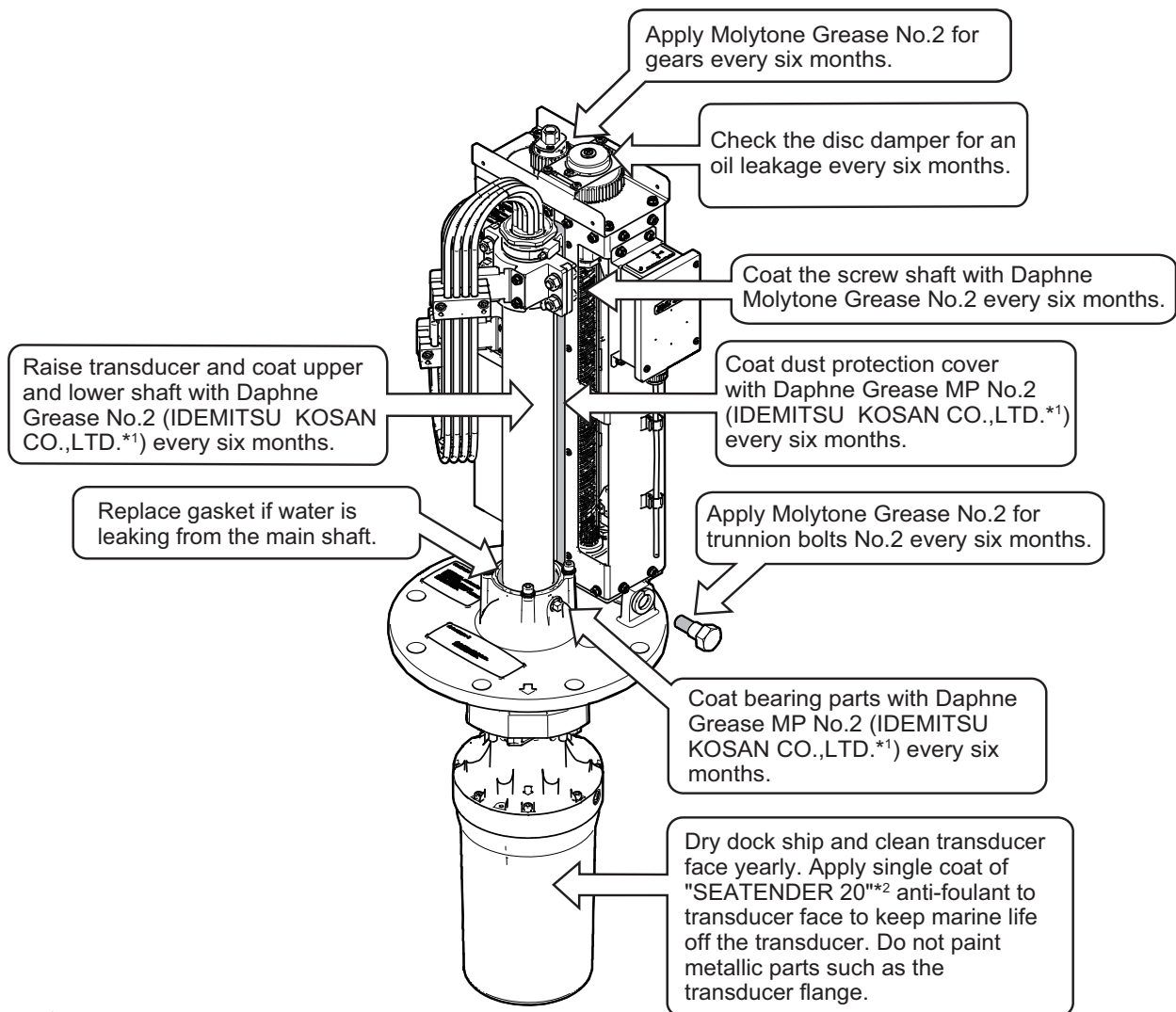

\*1 Equivalent greases:  
 SHOWA SHELL OIL: Shell Albania Grease S No.2  
 EXXON MOBIL: Mobilux EP No.2  
 NIPPON OIL CORPORATION: Multinox Grease No. 2

\*2 Equivalent coating:  
 CHUGOKU MARINE PAINTS, Ltd.: SEA GRANDPRIX 660HS

**Note 1:** Do not mix Sea Tender 20 and Sea Grand Prix 660HS and do not apply overlapping coats.

**Note 2:** It is possible to remove the Sea Tender 20 and then apply the Sea Grand Prix 660HS. To remove the paint, soak a nylon scrubber with thinner and wash the paint off. Do not use a scraper or sandpaper as they will damage the transmit surface transducer.

### 10.2.1 Greasing the gears

#### How to grease the gears

1. Unfasten the four bolts and remove the gear cover.

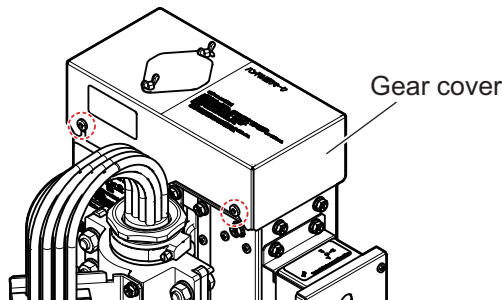

2. Apply the Molytone Grease No.2 to the motor gears and to the screw shaft gears.

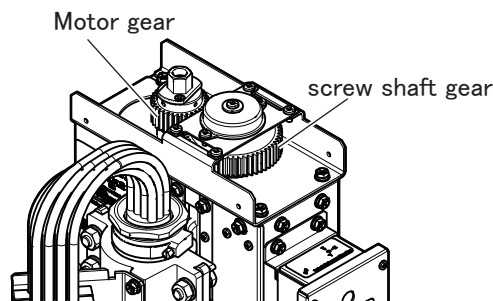

#### How to apply the grease to the bearing parts

Once every six months, remove the plug on the flange and inject Daphne Grease MP No. 2 from the grease nipple using a grease gun (supplied locally). Inject the grease from the plug side until it slightly overflows. After injection, wrap waterproof sealing tape (supplied locally) around the plug and reattach it to the flange.

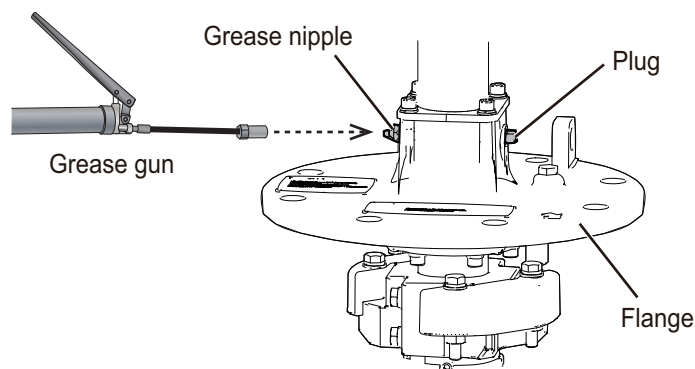

#### How to apply the grease to the gear shaft

1. Loosen the screws and remove the LSW cover.

Stroke Length	Screw No.
400 mm	6
600 mm	8

## 10. MAINTENANCE

2. Apply Molybdenum Grease No.2 to the screw shaft.

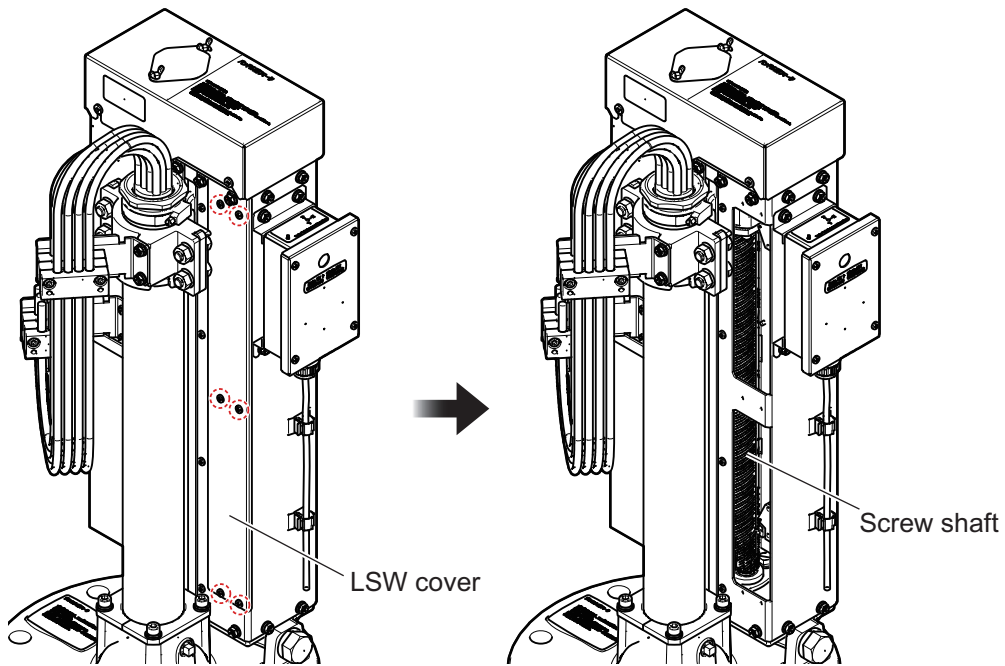

For 400 mm stroke length

### 10.2.2 How to replace the gasket

If water is leaking from the main shaft, replace the gasket. Two spare gaskets are provided on the cover of the main shaft.

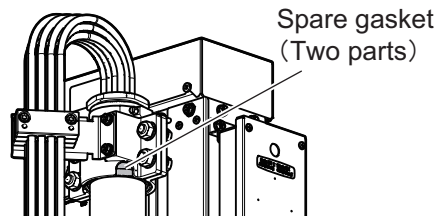

1. Unfasten four hex. head bolts to remove two seal support plates.
2. Cut and remove the gasket.

3. Take the spare gasket from the cover of the main shaft cover and set it to the main shaft.

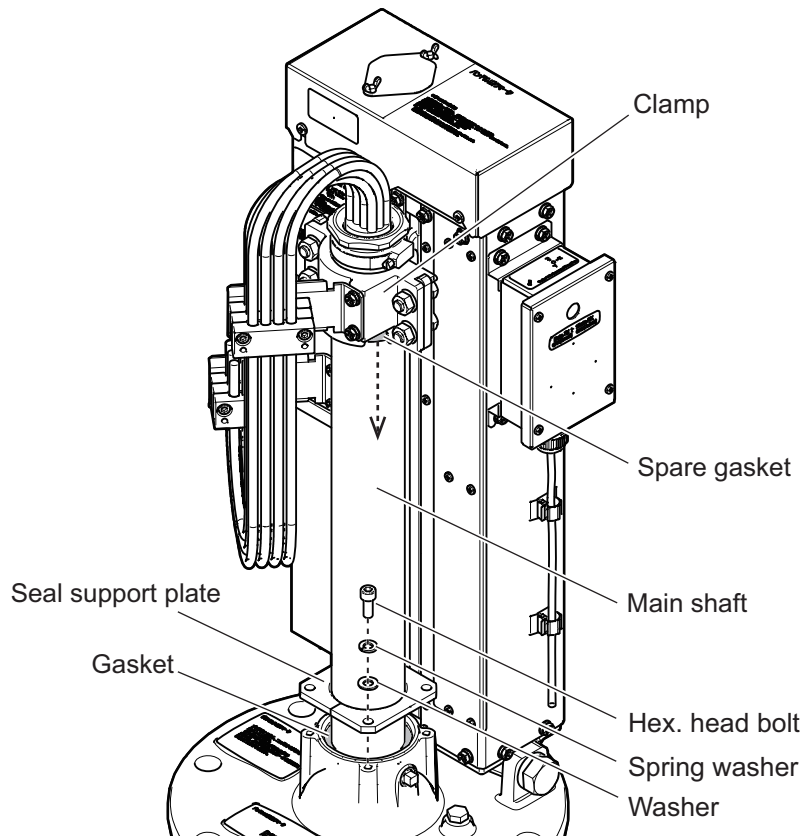

4. Use the washer, the spring washer, and the hex. head bolt to fasten the two seal support plates.  
Fasten the seal support plates as shown below.

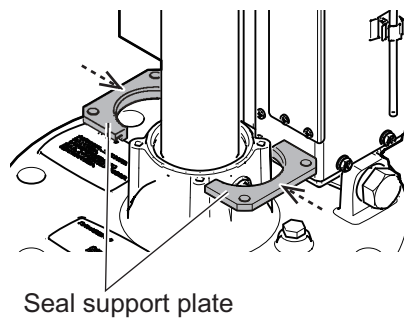

### 10.2.3 How to check the disc damper

Check the disc damper for oil leakage as shown below.

<b>⚠ CAUTION</b>	
<b>⚠</b>	<p>Handle industrial lubricants with care.                  In case of contact with lubricants, take the following first aid measures.</p> <ul style="list-style-type: none"> <li>- In case of contact with eyes, wash with water for 15 minutes and seek medical advice.</li> <li>- In case of skin contact, wash thoroughly with water and soap.</li> <li>- If swallowed, do not force vomiting, but seek medical advice immediately.</li> </ul>

1. Unfasten the four bolts and remove the gear cover.

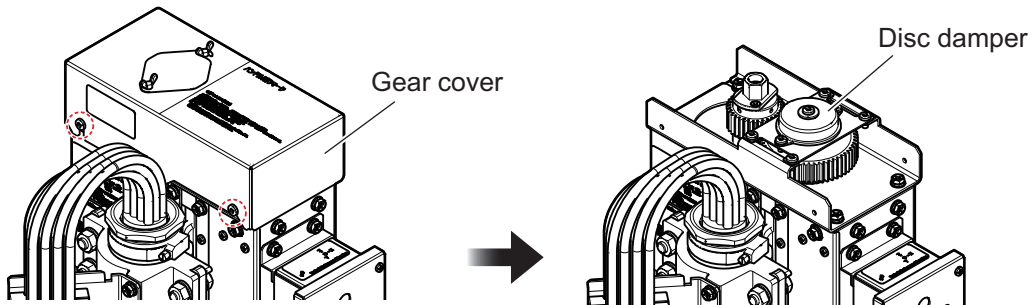

2. Check for oil leakage on the disc damper.

OK	NG
<p>Checked from above    Checked from side</p> <ul style="list-style-type: none"> <li>• Oil is not leaking.</li> <li>• Only a small amount is leaking.</li> </ul>	<p>Checked from above    Checked from side</p> <ul style="list-style-type: none"> <li>• Oil is leaking extensively.</li> </ul>

Leakage of a small amount of oil is not abnormal. In general, no replacement is necessary. However, when the leakage is significant, ask your FURUNO dealer for disc damper replacement.



## 10.3 How to Replace the Fuse

 <b>WARNING</b>
<p><b>Use the proper fuse.</b></p> <p>Use of a wrong fuse can cause fire or damage the equipment.</p>

The processor unit and transceiver unit carry fuses that protect the system from over-current and equipment fault. If the power cannot be applied, check the fuse on the processor unit first. If the fuse is blown, replace it with the specified new fuse. If the fuse blows again after replacement, contact your dealer. The fuse of the transceiver unit is installed inside the unit, and the voltage inside the unit is extremely high. Do not try to disassemble the unit for replacement. Serious injury can occur.

Unit	Type	Code No.	Remarks
Processor unit (Power cable)	FGBO-A 125V 15A PBF	000-155-827-10	For 12 VDC
	FGBO-A 125V 7A PBF	000-164-965-10	For 24 VDC
Transceiver unit (Inside the unit)	FGBO1 250V 15A PBF	000-155-788-10	

## 10.4 How to Replace the Battery

The battery on the motherboard in the processor unit backs up data. When the voltage is too low, the time and date may not be displayed correctly. However, if the ZDA sentence (time and date) is input from an external source, time and date are displayed according to the received data.

Name	Type	Code No.	Life
BATTERY KIT	BATTERY KIT-FJ	000-196-791-10	10 years

**Note 1:** When the voltage of the battery is 2.6 V or less, the error code "322" appears. In this case, have a qualified service technician replace the battery.

**Note 2:** Dispose of the battery in accordance with the local regulations. Insulate the + and - terminals of the battery with a tape or the like before disposal to prevent short circuit, which could cause a fire.

## 10.5 Trackball Maintenance

If the cursor moves abnormally, clean the trackball and inside the trackball housing (including the laser sensor cover) as shown below.

**Note:** Do not use solvents or chemicals for cleaning. It may cause deformations or damage. If cleaning is necessary, purified water is recommended.

1. Turn the retaining ring on the trackball module in the direction of the arrows (see the figure at the top of the next page to loosen it, then remove the retaining ring and ball.

## 10. MAINTENANCE

Put a clean, soft cloth on a flat surface, and place the removed ring and the ball on it.

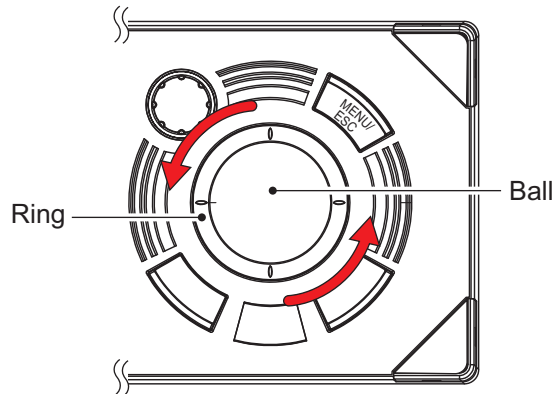

2. Remove all the dust, dirt and other moisture inside the case.
3. Use a clean swab or non-woven cloth, and wipe the laser sensor cover and the supports. If the swab or cloth is moistened with water, be careful not to leave any wiping marks on the laser sensor cover. It may affect the sensor detection function.

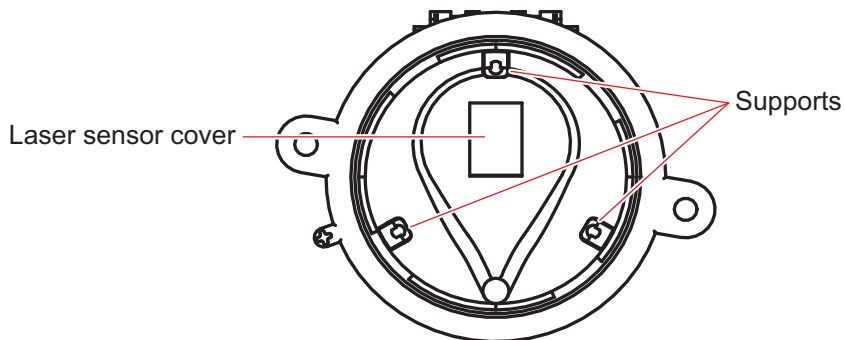

**Note:** When using a swab, be careful not to scratch the laser sensor cover with the shaft portion. Also, do not use cleaning tools such as tweezers.

4. Take the ball out of the ring.

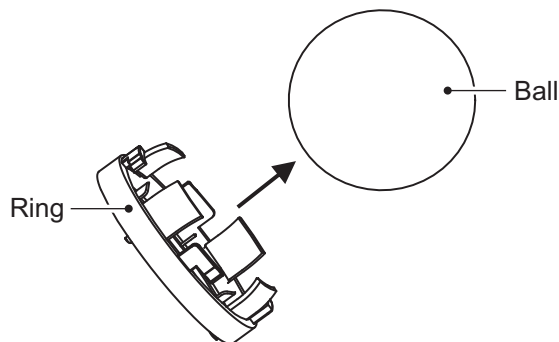

5. Use a clean swab or non-woven cloth, and wipe off all the dirt from the inner ring and the ball.

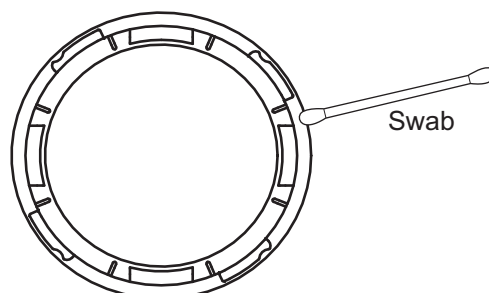

6. Attach the ring to the original positions.

## 10.6 Troubleshooting

The table below provides common symptoms of equipment troubles, and the means to rectify them. If the problem cannot be solved with the information supplied in this manual, contact your dealer for service.

**Note:** For the troubleshooting related to the remote controller SCU-001, see the user guide (C12-02301) shipped with the remote controller SCU-001.



### Troubleshooting

Symptom	Check, remedy
Cannot turn on power	<ul style="list-style-type: none"> <li>• Check cables between transceiver unit, processor unit, monitor unit, and control unit.</li> <li>• Check ship's mains to see if the battery voltage is normal.</li> <li>• Have a qualified technician check the fuses inside the transceiver unit.</li> </ul>
Cannot turn off power	<ul style="list-style-type: none"> <li>• Check cables between control unit and processor unit.</li> <li>• Press and hold the power key for approximately seven seconds to force-shut-down the equipment.</li> </ul>
Cannot operate the equipment	<ul style="list-style-type: none"> <li>• Check cables between control unit and processor unit.</li> <li>• Press and hold the power key for approximately seven seconds to force-shut-down, and turn it on again.</li> </ul>
Cannot operate the trackball	<ul style="list-style-type: none"> <li>• Check for dust or dirt inside the ball (including the laser sensor cover). Clean it in accordance with section 10.5.</li> <li>• Check the proximity sensor for dirt. Wipe it softly by using the soft dry cloth.</li> </ul>
Strange noise from hull unit	<ul style="list-style-type: none"> <li>• Gears may require re-greasing. See subsection 10.2.1 to apply grease.</li> </ul>
Bottom echo appears irregular	<ul style="list-style-type: none"> <li>• Rough seas. Distance to the bottom changes due to rolling and pitching.</li> <li>• Select short range. Long range makes transmission period longer, and ship's pitching and rolling are apt to affect detection of echo.</li> </ul>
Weak echoes	<ul style="list-style-type: none"> <li>• Output power set to minimum. Set the power to maximum from main menu→[User prg]→[Transmission Power].</li> <li>• Increase the gain with the <b>GAIN</b> control. See subsection 1.3.7.</li> <li>• If either near echoes or far echoes are weak, adjust the [Near Gain] or [Far Gain] as appropriate. See section 2.1.</li> </ul>
Somewhat strange color	<ul style="list-style-type: none"> <li>• Brilliance setting too low. Increase the monitor brightness.</li> </ul>
Picture contains noise	<ul style="list-style-type: none"> <li>• Equipment not grounded properly. Check equipment ground.</li> <li>• Power cable is too close to the signal cable. Relocate power cable or signal cable.</li> <li>• Debris may be on sea surface. Reject unwanted noise with the interference rejector or signal level from [User prg].</li> </ul>
Alarm releases no audio	<ul style="list-style-type: none"> <li>• If settings at main menu [Echo Display Area] are changed, on rare occasions the alarm is also silenced. Re-set the alarm parameters in this case.</li> </ul>

## 10.7 Alarm and Warning

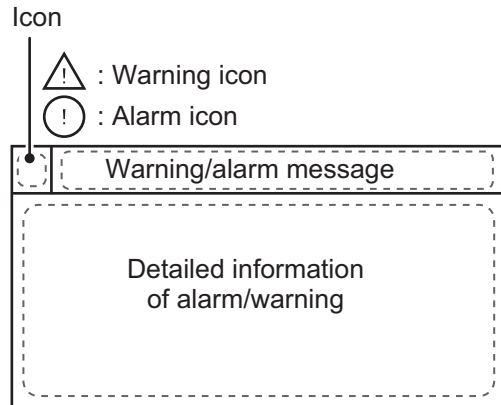
When an alarm/warning condition occurs, the system releases an audible alert (buzzer), and the alarm window appears (flashing). The alarm (or warning) icon appears in the window with a message and basic information. Warnings appear in red color while alarms appear in yellow. The alert (buzzer) can be stopped by right-click. See the table below for the alarm messages.



Message	Level	Meaning, Remedy	Behavior
<b>Transceiver unit</b>			
<< ELECTRIC CHARGE!! >>	Warning	<b>Meaning:</b> B voltage of capacitors in the transceiver unit have not charged to pre-determined voltage within the specified time. <b>Remedy:</b> Right-click to silence the buzzer, and turn th power off. Contact your dealer.	The warning window stops flashing, but remains on-screen until the cause is solved.
<< NO RESPONSE FROM TRANS-CEIVER UNIT!! >>	Warning	<b>Meaning:</b> There is no reply from the transceiver unit. <b>Remedy:</b> Right-click to silence the buzzer. Check the onboard power breaker. If the same problem occurs, contact your dealer.	The warning window stops flashing, but remains on-screen until the cause is solved.
<b>Hull unit, transceiver unit</b>			
<< TRANSDUCER NOT RETRACT-ED!! >>	Warning	<b>Meaning:</b> The transducer is not retracted within 20 seconds after pressing the  key. All LED lamps next to this key light up when this warning occurs. <b>Remedy:</b> Right-click to silence the buzzer. The cause may be tangled nets, bent shaft, or faulty in the raise/lower the transducer. See section 10.11 for how to retract the transducer manually.	The warning window stops flashing, but remains on-screen until the cause is solved.
<< TRANSDUCER NOT PROTRUD-ED!! >>	Warning	<b>Meaning:</b> The transducer is not protruded within 20 seconds after pressing the  key. All LED lamps next to this key light up when this warning occurs. <b>Remedy:</b> Right-click silence the buzzer. Turn the transceiver and processor unit power off from the breaker. The cause may be faulty in the raise/lower unit. Contact your dealer.	The warning window stops flashing, but remains on-screen until the cause is solved.
<< TD WRONG PO-SITION ALARM!! >>	Warning	<b>Meaning:</b> The transducer is stopped at an incorrect position. <b>Remedy:</b> Press key to return the transducer to the correct position, then right-click to silence the buzzer.	The warning window stops flashing, but remains on-screen until the cause is solved.

Message	Level	Meaning, Remedy	Behavior
<b>Processor unit</b>			
<< SHIP SPD ALARM!! >>	Alarm	<b>Meaning:</b> Ship's speed exceeded the pre-determined speed (see page 9-6) when the transducer is protruded. <b>Remedy:</b> Right-click to silence the buzzer. Reduce the ship's speed, and retract the transducer.	The alarm window disappears.
	Alarm	<b>Meaning:</b> Ship's speed exceeded the pre-determined speed (see page 9-6) when the transducer is being raised or lowered. <b>Remedy:</b> Right-click to silence the buzzer, and reduce the ship's speed.	The alarm window disappears.
<< AUTOMATIC RETRACT ALARM!! >>	Alarm	<b>Meaning:</b> Ship's speed exceeded the pre-determined speed (see page 9-6) when the transducer is being raised or lowered. The transducer is automatically retracted. <b>Remedy:</b> Right-click to silence the buzzer.	The alarm window disappears.

### Warning and alarm priorities

When more than one warnings occur at the same time, the warning with the highest priority is displayed. The order of priority is indicated in the table below.

Priority	Message	Remarks
1	<< TRANSDUCER NOT RETRACTED!! >>* << TRANSDUCER NOT PROTRUDED!! >>*	Remains on-screen until the cause is solved. The warning disappears by rebooting the power after the cause is solved.
2	<< ELECTRIC CHARGE!! >>*	
3	<< NO RESPONSE FROM TRANSCIEVER UNIT!! >>	Remains on-screen until the cause is removed or rectified.

\*: Warning message remains on-screen even if any warning with higher priority occurs.

## 10.8 Error Codes

When an error occurs inside the equipment, the error window shown below is shown at the bottom of the display. The equipment displays an icon along with (flashing) three-digit error code in yellow color. In case of multiple errors, error codes appear in numerical order, up to five error codes. See ERROR CODE LIST on page AP-4. For any error code, report error code number to your dealer.

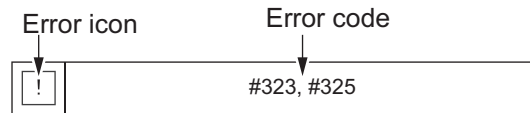

## 10.9 Status Messages

The status message appears at the bottom of the display to alert the operator as shown in the table below.

Status message	Meaning
TX Off	Transmission turned off from the menu. (main menu [System] → [Test]→[Transmission]→[OFF])

## 10.10 Tests

A comprehensive diagnostic facility is provided for testing the equipment. If you feel the equipment is not working properly, conduct the test to find the cause. If [NG] (No Good) appears in the test result for any test, contact your dealer for advice.

**Note:** Check that the system is correctly connected before conducting any test.

### 10.10.1 How to use the test menu

1. Open the menu.
2. Select the [System] tab from the main menu.

3. Select the [Test] tab from the sub menu.

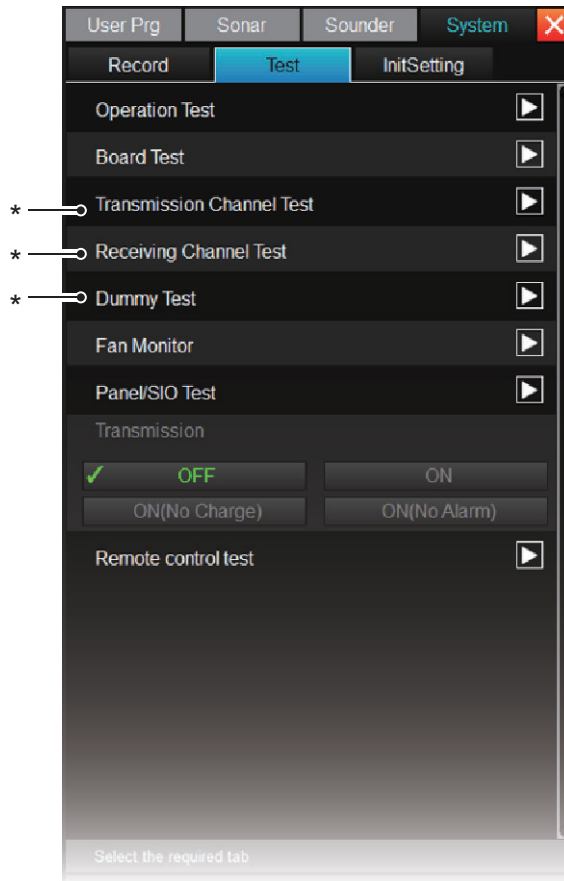

\*: For technician use.

**Note:** To find a noise source, turn transmission OFF under Test. Be sure to turn it ON again after the test. ([ON (No Change)] and [ON (No Alarm)]) are for service technicians only.)

### 10.10.2 Operation test

The operation test checks the operational status of each unit in the system. To conduct this test, select [Test]→[Operation Test]. Press the **MENU/ESC** key to finish the test.

## 10. MAINTENANCE

OPERATION TEST	
<b>Processor Unit</b> 105-XXXX-XX.XX 105-XXXX-XX.XX  RAM = OK UWF = Enabled MAC Address = ***** IP Address = ***** Subnet Mask = *****  Monitor1 = 1280x1024 Monitor2 = USB1 = OK USB2 = USB3 = USB4 = SSD = OK CPU Temp = 47.0°C Board Temp = 41.5°C Battery = 3.0V	<b>Transceiver Unit</b> TRCPU 105-XXXX-XX.XX 105-XXXX-XX.XX 105-XXXX-XX.XX  ROM = OK S1 00000000(00) RAM = OK S2 0000(0) DATA = OK S3 0000(0) S4 0000(0) MAC Address = ***** IP Address = ***** Subnet Mask = *****  TRX 000000000000  PWR 12V = 12.1V +B = 107.4V  <b>Hull Unit</b> HMS 105-XXXX-XX.XX test = OK Pitch = 0 Roll = 0
<b>Control Unit</b> 105-XXXX-XX.XX 105-XXXX-XX.XX 105-XXXX-XX.XX  ROM = OK RAM = OK	
<b>Switch Box</b> 105-XXXX-XX.XX  <b>Control Unit</b> 105-XXXX-XX.XX 105-XXXX-XX.XX 105-XXXX-XX.XX  ROM = OK RAM = OK	
Press Menu/Esc key to cancel.	

Displays only when a compact switch box or sub-control unit is connected.

OK: Operating properly; NG: Error found  
XX: Program ver. number

### How to read the test results

Item	Description
<b>Processor Unit</b>	
105-XXXX-XX.XX	Displays the OS program number.
105-XXXX-XX.XX	Displays the application program number.
RAM	Displays the read-write test result of the memory ([OK] (white) or [NG] (red)).
UWF	Displays the writing restriction status to the C drive ([Enabled] (normal) or [Disabled] (abnormal)).
MAC Address	Displays the MAC address.
IP Address	Displays the IP address.
Subnet Mask	Displays the subnet mask.
Monitor 1, 2	Displays the resolution of the monitors connected. If no sub-monitor connected, nothing is displayed in [Monitor 2].
USB 1 to 4	Displays [OK] if any equipment is connected to the USB port.
SSD	Displays the SSD check result ([OK] or [NG]).
CPU Temp	Displays the CPU temperature.
Board Temp	Displays the board temperature.



Item	Description
Battery	Displays the voltage of the backup battery.
<b>Control Unit: Displayed below two results only when two units are connected.</b>	
105-XXXX-XX.XX	Displays the starter program number.
105-XXXX-XX.XX	Displays the boot program number.
105-XXXX-XX.XX	Displays the application program number.
ROM	Displays the read-write test result of the memory ([OK] (white) or [NG] (red)).
RAM	
<b>Switch Box: Displayed only when connected.</b>	
105-XXXX-XX.XX	Displays the program number.
<b>Transceiver Unit</b>	
TRCPU	
105-XXXX-XX.XX	Displays the PreLoader program number.
105-XXXX-XX.XX	Displays AppLoader program number.
105-XXXX-XX.XX	Displays the unified program number for CPU and FPGA.
ROM	Displays the read-write test result of the memory ([OK] (white) or [NG] (red)).
RAM	
DATA	Displays the data test result. If all the board test results (see section 10.10.3) for [S2T], [RFP], [FFP], [S2R], [R2F], and [FRAM] show OK, [OK] is displayed.
S1 to S4	Displays the DIP switch settings.
MAC Address	Displays the MAC address.
IP Address	Displays the IP address.
Subnet Mask	Displays the subnet mask.
TRX	
000000000000	Display the revision number for TRX board.
PWR	
12V	Displays 12 V voltage.
+B	Displays +B voltage for transmission.
<b>Hull Unit</b>	
HMS	
105-XXXX-XX.XX	Displays the program number.
test	Displays the test result ([OK] (white) or [NG] (red)).
Pitch	Displays the pitch angle.
Roll	Displays the roll angle.

### 10.10.3 Board test

The board test checks all the circuit boards in the system. To conduct this test, select [Board Test] from the [Test] menu. Press the **MENU/ESC** key to finish the test.

BOARD TEST					
<b>TRCPU</b>					
105-XXXX-XX.XX	ROM = OK	S2T = OK	HMS	105-XXXX-XX.XX	22V = 21.5V
Revision = 0	RAM = OK	RFP = OK	Revision = 0	S1 0000(0)	Tacc = +28.2°C
	FRAM = OK	FFP = OK	ROM = OK		Tgyr = +32.5°C
		S2R = OK	RAM = OK		Accel = OK
		R2F = OK			Gyro = OK
<b>TRX1</b>	ROM = OK		<b>TRX2</b>	ROM = OK	
105-XXXX-XX.XX	RAM = OK		105-XXXX-XX.XX	RAM = OK	
Revision = 0	TFP = OK		Revision = 0	TFP = OK	
12V = OK	T2S = OK		12V = OK	T2S = OK	
<b>TRX3</b>	ROM = OK		<b>TRX4</b>	ROM = OK	
105-XXXX-XX.XX	RAM = OK		105-XXXX-XX.XX	RAM = OK	
Revision = 0	TFP = OK		Revision = 0	TFP = OK	
12V = OK	T2S = OK		12V = OK	T2S = OK	
<b>TRX11</b>	ROM = OK		<b>TRX12</b>	ROM = OK	
105-XXXX-XX.XX	RAM = OK		105-XXXX-XX.XX	RAM = OK	
Revision = 0	TFP = OK		Revision = 0	TFP = OK	
12V = OK	T2S = OK		12V = OK	T2S = OK	

Press Menu/Esc key to cancel.

OK: Operating properly; NG: Error found  
 XX: Program ver. number

#### How to read the test results

Item	Description
<b>TRCPU</b>	
105-XXXX-XX.XX	Displays the application program number.
Revision	Displays the revision number for TRCPU board.
ROM	Displays the sum check result.
RAM	Displays the read-write test result.
FRAM	Displays the read-write test result for FBM.
S2T	Displays the SoC-TRX command check result.
RFP	Displays the expected value test result for RXBMF_FPGA.
FFP	Displays the expected value test result for FLT_FPGA.
S2R	Displays the data transfer test result for SoC to RXBMF_FPGA.
R2F	Displays the data transfer test result for RXBMF_FPGA to FLT_FPGA.
<b>HMS</b>	
105-XXXX-XX.XX	Displays the CPU program number.
Revision	Displays the revision number for HMS board.
S1	Displays the DIP switch settings.
ROM	Displays the sum check result.
RAM	Displays the read-write test result.
22V	Displays the 22 V voltage check result.

Item	Description
Tacc	Displays the measured temperature of the accelerator sensor.
Tgyr	Displays the measured temperature of the gyro sensor.
Accel	Displays the self-test result of the accelerator sensor.
Gyro	Displays the self-test result of the gyro sensor.
<b>TRX1 to 12</b>	
105-XXXX-XX.XX	Displays the FPGA program number.
Revision	Displays the revision number for TRX1 to 12.
12V	Displays the 12 V voltage check result.
ROM	Displays the sum check result.
RAM	Displays the read-write test result.
TFP	Displays the expected value test result for TRX_FPGA.
T2S	Displays the data transfer test result for TRX_FPGA to SoC.

#### 10.10.4 Fan monitor test

The fan monitor test checks the fan RPM of the fans inside the transceiver unit, and processor unit. To conduct this test, select [Fan Monitor] from the [Test] menu. Any abnormality in the speed is indicated in red. Press the **MENU/ESC** key to finish the test.

FAN MONITOR	
Transceiver Unit	
TRCPU FAN01 Speed = 4080rpm	TRCPU FAN05 Speed = [Reserve]
TRCPU FAN02 Speed = 3900rpm	TRCPU FAN06 Speed = [Reserve]
TRCPU FAN03 Speed = 4320rpm	TRCPU FAN07 Speed = [Reserve]
TRCPU FAN04 Speed = 4080rpm	
Processor Unit	
CPU BOARD_FAN1 Speed = 4045rpm	
Press Menu/Esc key to cancel.	

**How to read the test results**

Item	Description
<b>Transceiver Unit</b>	
TRCPU FAN01 to 04 Speed	Displays the fan RPM (error judgment: less than 2856 rpm).
TRCPU FAN05 to 07 Speed	Displays "Reserve".
<b>Processor Unit</b>	
CPU BOARD_FAN1 Speed	Displays the fan RPM (error judgment: less than 2394 rpm).

**10.10.5 Panel test / SIO test**

The panel test or SIO test checks the operational status of the control unit's keys, knobs, and trackball. To conduct this test, select [Panel/SIO Test] from the [Test] menu. Press the **MENU/ESC** key to finish the test.

————— PANEL TEST —————

1\*

0	0	0	0			0	0
					0	d = 0	
		0	0			X = 0	
0						Y = 0	
0					0 0		
0	0	0	0	0	0 0	0	1 0

2\*

0	0	0	0			0	0
					0	d = 0	
		0	0			X = 0	
0						Y = 0	
0					0 0		
0	0	0	0	0	0 0	0	1 0

————— SIO TEST —————

NMEA1 =	AD10 =
NMEA2 =	
NMEA3 =	
NMEA4 =	
NMEA5 =	

Press Menu/Esc key to cancel.

\*: When two control units are connected, 1 is for the main control unit and 2 is for the sub-control unit.

**Panel test**

The panel test display layout corresponds to the key layout of the control unit. Do the following operations to check if the corresponding keys, buttons, knobs, etc. work properly.

Item	Check method
Keys, left button, right button	1) Shows "1" while pressing keys other than the power key  or the <b>MENU/ESC</b> key. 2) Shows "0" after releasing the pressed keys or button.
Wheel knob	1) Shows "1" while pressing the wheel knob. 2) Shows "0" when releasing the wheel knob. 3) Shows positive value in [d] when turning clockwise. 4) Shows negative value in [d] when turning counterclockwise.
Knobs (USER PROG, GAIN, RANGE)	1) Shows positive value when turning clockwise. 2) Shows negative value when turning counterclockwise.
TILT lever	1) Shows "1" when turning the lever upward. 2) Shows "2" when turning the lever downward. 3) Shows "0" when releasing the lever.
Trackball	1) Shows positive value in "X" when turning clockwise. 2) Shows negative value in "X" when turning counterclockwise. 3) Shows positive value in "Y" when turning upward. 4) Shows negative value in "Y" when turning downward.

**Note:** When a small switch box is connected, only operation upward/downward can be checked, otherwise "0" is shown.

**SIO test**

SIO test result is usually left blank. This test is done at a factory.

**10.10.6 Remote controller test**

The remote controller test checks the operational status of the keys and joystick on the remote controller SCU-001 (option). Status of each remote controller can be checked. To conduct this test, select [Remote control test] from the [Test] menu. Press the **MENU/ESC** key to close the result.

Arrow cursor

Remote controller Key Test

A : 0	B : 0	C : 0
JOYSTICK PUSH : 0		
D : 0	E : 0	
GAIN ↑ : 0	TILT ↑ : 0	RANGE ↑ : 0
GAIN ↓ : 0	TILT ↓ : 0	RANGE ↓ : 0

Remote controller Status

Remote controller	No.1	No.2	No.3	No.4
Connect	Connected	Not set	Not set	Not set
Battery	87%	--	--	--

Press Menu/Esc key to cancel.

*Remote controller test screen*

**Remote controller key test**

Do the following operations to check keys and joystick.

Item	Check method
Key	1) Shows "1" while pressing keys other than the power key . 2) Shows "0" after releasing the pressed keys.
Joystick	1) Shows "1" while pressing the joystick. 2) Shows "0" when releasing the joystick. 3) Moves the cross-hair cursor as you operate the joystick.

**Remote controller status**

You can check the connection status and the remaining battery of the remote controllers, No. 1 to No. 4.

Item	Description
Connect	Displays the status of remote controllers. [Not set]: Pairing is not established. [Not connected]: Not connected via wireless LAN. [Connected]: Connected via wireless LAN.
Battery	Displays the remaining battery level (only when the above status is [Connected]).

## 10.11 How to Retract the Transducer Manually

If the transducer cannot be raised automatically, carry out the following procedure and manually raise the transducer.



### CAUTION

 **Turn the breaker off when raising the transducer manually.**

If raising or lowering the transducer while the breaker is turned on, the transducer motor automatically rises, which may cause injury.

1. Turn off the breaker.
2. Unscrew the two butterfly screws, open the handle cover on the gear cover, and attach the ratchet wrench (local supply, 19 mm).

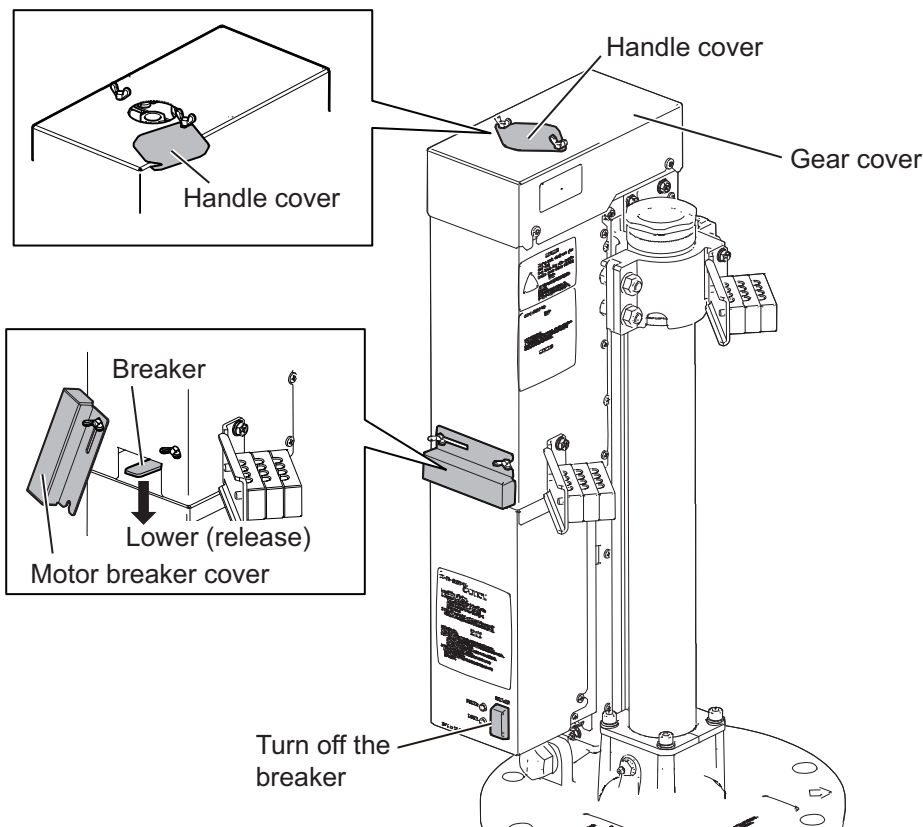

3. Unfasten the butterfly screws on the motor brake cover, open the cover and release the brake.
4. Turn the ratchet wrench counterclockwise to raise the transducer.  
**Note:** If the wrench does not move smoothly, do not force it. If you turn it with strong force, it may cause damage to the attached parts.
5. Remove the ratchet wrench, and close the gear cover handle cover and motor brake cover.

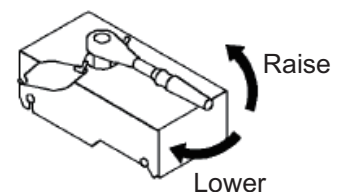

## 10.12 How to Check the Brake In the Hull Unit

The shafts of the hull unit are held in place by a motor brake. The motor brake should be checked once a year for proper operation. Contact your local FURUNO dealer for check.

**Note 1:** Before carrying out the check, make sure no one is near the hull unit or transducer.

**Note 2:** Record the check results in the brake check sheet on page AP-8.

### How to check the gap of the motor brake.

1. Unfasten the six screws on the side of the motor cover and remove the motor cover.

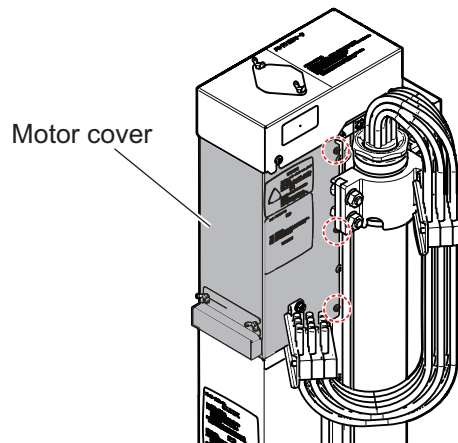

2. Measure the gap between the stator and armature.  
Gap measurements should be taken at three points horizontally. Check that the gap between the stator and armature is within the range of 0.05 mm to 0.4 mm when the brake is off (when the brake is not released).

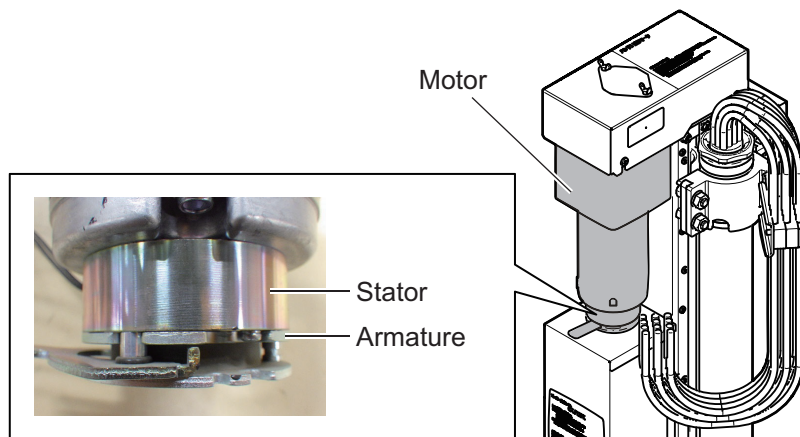

**Note:** Replace the motor if it is out of the range.

3. Attach the motor cover with the screws unfastened in step 1.



# APPX. 1 MENU TREE

The factory values in the [User Prg] menu vary depending on the user program setting (P1-P10) (see section 6.2). In this menu tree, the factory values for the user program setting "P1" are shown.

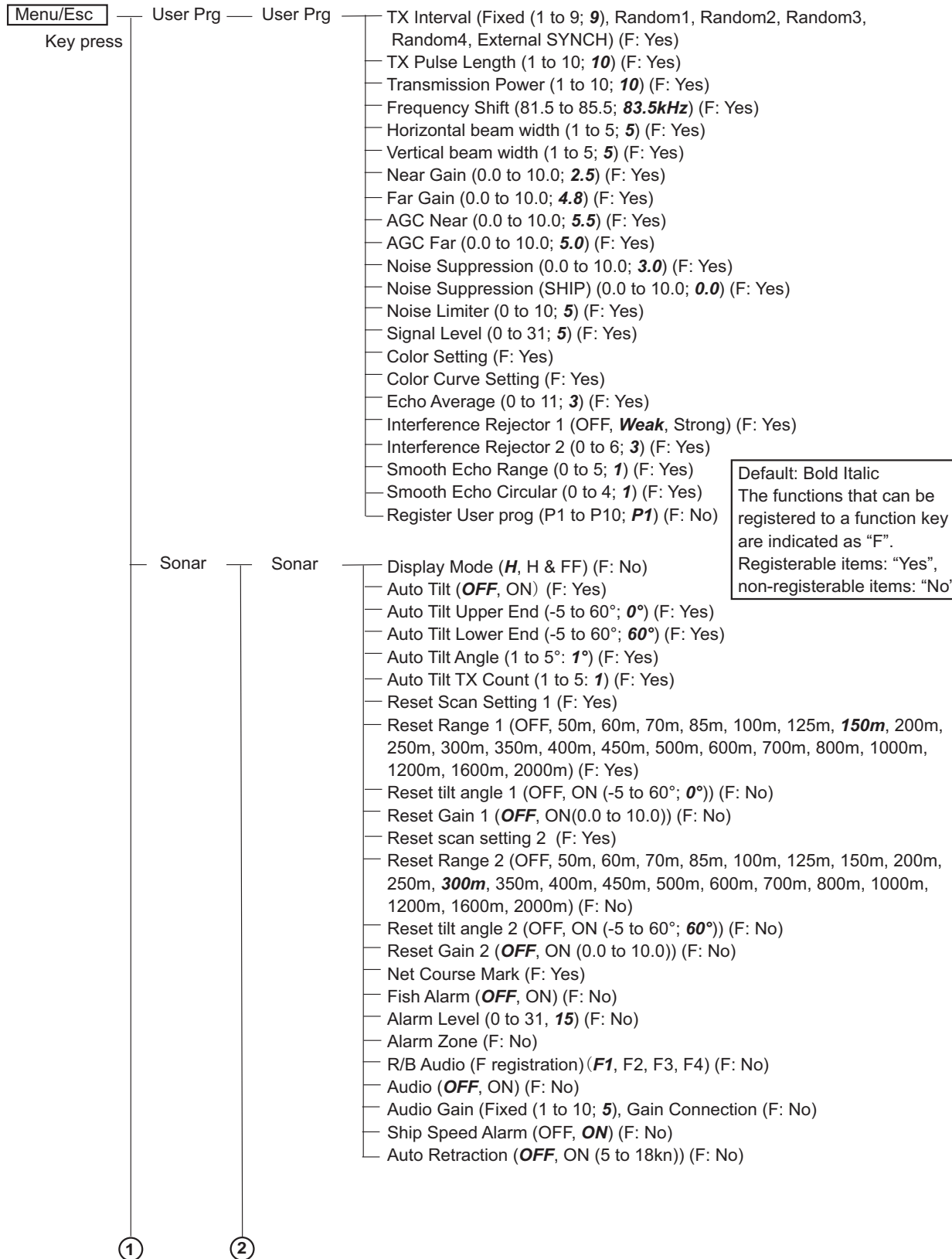

(Continue to the next page)

APPX. 1 MENU TREE

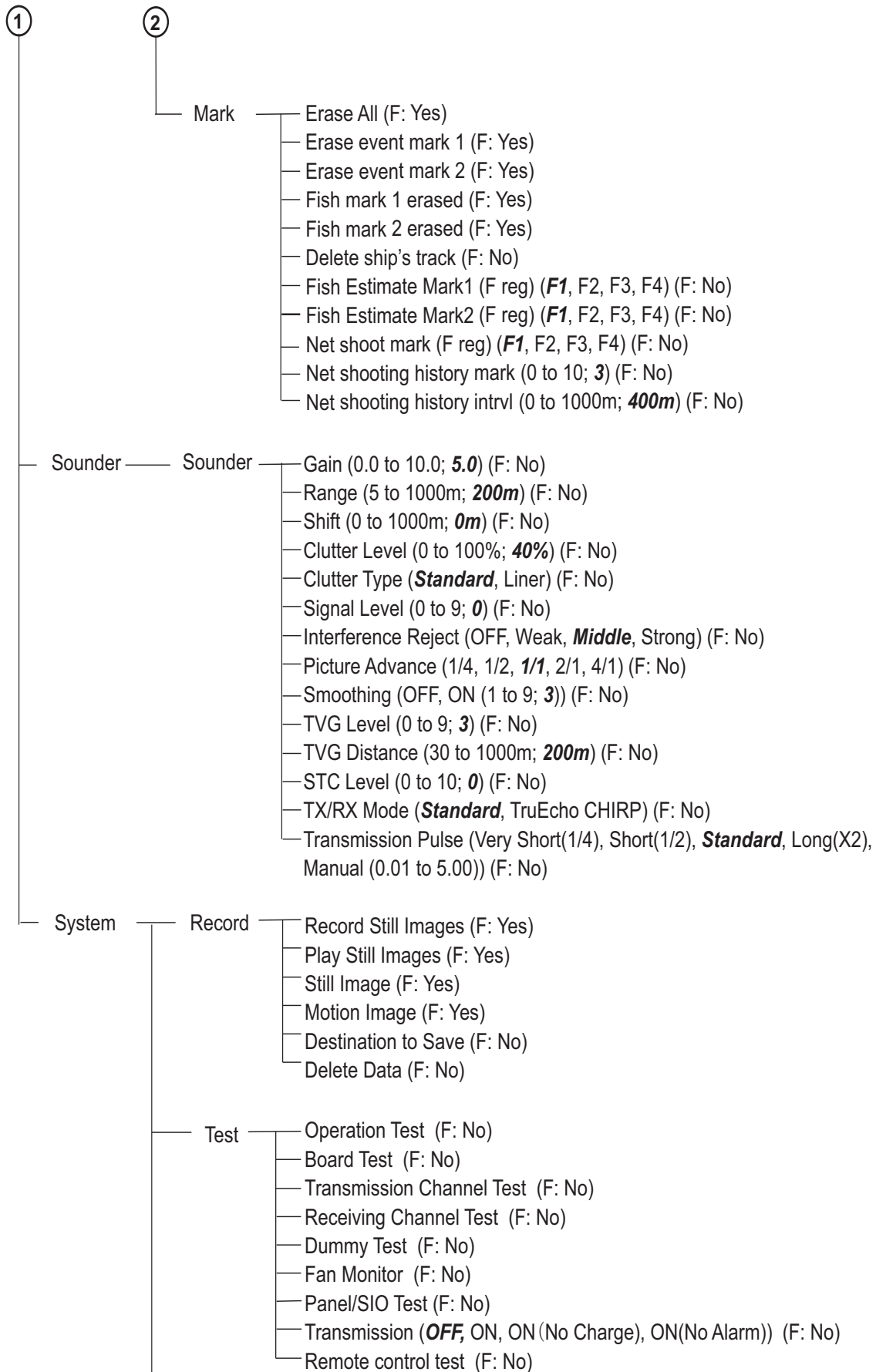

② (Continue to the next page)

②

InitSetting

- Option List (F: No)
- Remote Key Setting (Ch1) (**Tilt Up**, Tilt Down, Range Up, Range Down, Gain Up, Gain Down, User Prog Up, User Prog Down, Retract, Full-Protrude, Event Mark1, Event Mark2, Fish Mark1, Fish Mark2, Estimate Mark1, Estimate Mark2, Net Shoot Mark, Erase Marks, Target Lock, Off Center, Range/Bearing, F1, F2, F3, F4, F5, F6, F7, F8, F9, F10) (F: No)
- Remote Key Setting (Ch2)(Same as Ch1; **Tilt Down**) (F: No)
- Remote Key Setting (Ch3)(Same as Ch1; **Range Up**) (F: No)
- Remote Key Setting (Ch4)(Same as Ch1; **Range Down**) (F: No)
- Remote Key Setting (Ch5)(Same as Ch1; **Gain Up**) (F: No)
- Remote Key Setting (Ch6)(Same as Ch1; **Gain Down**) (F: No)
- Remote Key Setting (Ch7)(Same as Ch1; **User Prog Up**) (F: No)
- Remote Key Setting (Ch8)(Same as Ch1; **User Prog Down**) (F: No)
- Remote Key Setting (Ch9)(Same as Ch1; **F1**) (F: No)
- Remote Key Setting (Ch10)(Same as Ch1; **F2**) (F: No)
- Connect remote control (F: No)
- Disconnect remote control (F: No)
- Set remote control key (A) (User Prog Up, User Prog Down, Retract, Full-Protrude, Event Mark1, Event Mark2, Fish Mark1, Fish Mark2, Estimate Mark1, Estimate Mark2, Net Shoot Mark, Erase Marks, Target Lock, Off Center, Range/Bearing, **F1**, F2, F3, F4, F5, F6, F7, F8, F9, F10, Menu/Esc) (F: No)
- Set remote control key (B) (Same as (A); **F2**) (F: No)
- Set remote control key (C) (Same as (A); **F3**) (F: No)
- Set remote control key (D) (Same as (A); **Event Mark1**) (F: No)
- Set remote control key (E) (Same as (A); **Event Mark2**) (F: No)
- Remote control key list (F: No)
- Remote control status (OFF, **ON**) (F: No)
- Distance Unit (Sonar) (**m**, ft) (F: No)
- Distance Unit (Fish finder) (**m**, ft, fm, pb) (F: No)
- Trackball Speed (Slow, **Normal**, Fast) (F: No)
- Dimmer (0 to 15; **7**) (F: Yes)
- Key Beep Volume (0 to 7; **5**) (F: No)
- Speaker Volume (0 to 5; **3**) (F: No)

# APPX. 2 ERROR CODE LIST

The table below shows the error code, description, and meaning and remedy for the errors possibly occur in this equipment. Service technicians can check the detailed contents in [Error Code List] of [System/Maintenance] menu. If the error is not still solved after conducting the remedy, contact your dealer.

Error Code	Error Message	Description	Remedy
<b>Hull Unit</b>			
100	Transducer Position Not Found	Multiple signals asserted for the transducer position.	Move the transducer and restart the system.
115	Motion Sensor Data COMM Error	Communication error in the motion sensor.	Restart the system.
116	Motion Sensor Data Error		
139	Motion Sensor Calibration Data Error	Motor Sensor Calibration Data Error	Restart the system.
<b>Transceiver Unit</b>			
200	B Voltage Fault	An abnormal voltage was detected.	<ul style="list-style-type: none"> <li>Restart the system.</li> <li>Conduct the operation test, and check the voltage for the +B item in the PWR section of the test results (see section 10.10.2).</li> </ul>
201	Transceiver Fan Error	Fan RPM has lowered.	<ul style="list-style-type: none"> <li>Conduct the FAN monitor test (see section 10.10.4) and check that the value for the [Transceiver Unit] fan is not red. If any fan's RPM is shown in red color, consult your local dealer for service.</li> <li>Restart the system.</li> </ul>
205	Motion Sensor Malfunction	Error in the motion sensor.	Restart the system.
206	TRX CALIB Verification Error	Problem in the data on the TRX board.	Restart the system.
207	TRX CALIB Check Error		
210	Processor Unit Input Error	Communication problem with the processor unit.	Restart the system.

Error Code	Error Message	Description	Remedy
215	SoC PLL Error	Problem with the transceiver board(s).	<ul style="list-style-type: none"> <li>Conduct the board test (see section 10.10.3) and check that the results for all items do not appear in red.</li> <li>Restart the system.</li> </ul>
216	RXBMF_FPGA PLL Error		
217	FLT_FPGA PLL Error		
220	TRX Board1 COMM Error		
221	TRX Board2 COMM Error		
222	TRX Board3 COMM Error		
223	TRX Board4 COMM Error		
224	TRX Board5 COMM Error		
225	TRX Board6 COMM Error		
226	TRX Board7 COMM Error		
227	TRX Board8 COMM Error		
228	TRX Board9 COMM Error		
229	TRX Board10 COMM Error		
230	TRX Board11 COMM Error		
231	TRX Board12 COMM Error	Problem with the transceiver board(s).	Conduct the board test (see section 10.10.3) and check that the results for all items do not appear in red.
243	RXBMF_FPGA Timeout		
244	FLT_FPGA Timeout		
245	12V Voltage Malfunction		
248	PreLoader Error	Transceiver PreLoader program error.	Restart the system.
<b>Processor Unit</b>			
301	Processor Unit Fan Error	Fan RPM has lowered.	<ul style="list-style-type: none"> <li>Conduct the FAN monitor test (see section 10.10.4) and check that the value for each fan is not red. If any fan's RPM is shown in red color, consult your local dealer for service.</li> <li>Restart the system.</li> </ul>
304	Transceiver COMM Error	Error occurred in communication with transceiver unit.	Restart the system.
305	Main Control COMM Error	Error occurred in communication with the control unit.	Restart the system.
306	Sub Control COMM Error		

APPX. 2 ERROR CODE LIST

<b>Error Code</b>	<b>Error Message</b>	<b>Description</b>	<b>Remedy</b>
310	Backup Memory Error	Backup memory write error. Setting reset to its factory default.	Restart the system.
311	Backup Data Error	A backup data faultily set to default.	Restart the system.
320	Disk Space Error	No available disk space.	Remove unnecessary files from [System] menu → [Record] → [Delete Data] (see section 7.6).
321	Gain Adjust Value Fault	Fault of gain adjust value.	Restart the system power.
322	Low Battery	Battery voltage is dropped.	Consult your local dealer for battery replacement.
323	NMEA Port Error	External input port recognition error.	Restart the system.
324	IP Address Conflict	System IP address conflict.	More than one connection has the same IP address. Have your local dealer check that the IP addresses are set as follows: <ul style="list-style-type: none"> <li>• Processor Unit: 4</li> <li>• Transceiver Unit: 3</li> </ul>
325	DLL Error	The DLL (Dynamic Link Library) file was not recognized or found.	Restart the system.
326	Grade authentication error 1.	Cannot decrypt authentication file.	Restart the system.
327	Grade authentication error 2.		

# APPX. 3 DATA INPUT REQUIREMENTS

The following table outline the external data input requirements from the listed functions and/or displayed items.

Function/Item	See...	Required data
Bearing mark	page 3-3	Heading data
Own ship mark	page 1-12	Heading data, Speed/Course data
North mark	page 3-1	
Target Lock mark	page 3-3	
Presentation modes	page 3-10	
Audio bearing mark	page 3-6	
Estimate mark	page 3-10	
Fish mark	page 3-6	
Event mark	page 3-9	
Net Course mark	page 3-13	
Net Shoot mark	page 3-14	
Net Shoot History mark	page 3-14	
Heading mark	page 1-12	
Bearing scale	page 1-12	
Tracks	page 1-13	
Fish tracks	page 3-1	
Net movement (Net move plot)	page 3-14	Heading data, Speed/Course data, Current data
Current mark	page 1-12, page 3-14	
Cursor data (coordinates, etc)	page 1-20	Position data
Depth on track	page 1-13	Water depth data
Temperature graph	page 5-3	Water temperature data
Water temperature on track	page 1-13	

# APPX. 4 BRAKE TEST SHEET

The motor brake should be checked once a year for any abnormalities. Please fill out the test results to the check sheet below.

## Brake Check Sheet for CSH-10 Hull Unit

Unit :  CSH-103     CSH-104  
 Serial No. : \_\_\_\_\_

Note:

- A. Follow the procedures for "How to Check the Brake in the Hull Unit" in Operator's Manual.
- B. While the Hull Unit is running, check the brake with care not to be caught up in the gear.
- C. Before doing the check, make sure no one is near the hull unit and transducer.

Check item	Method, standard	Date										
Measuring the gap in the motor brake												
Gap measurement between stator and armature	Gap between stator and armature must be within 0.05 to 0.4mm when no power is applied (Circumference 3 locations).	OK/NG	OK/NG	OK/NG	OK/NG	OK/NG	OK/NG	OK/NG	OK/NG	OK/NG	OK/NG	OK/NG
		OK/NG	OK/NG	OK/NG	OK/NG	OK/NG	OK/NG	OK/NG	OK/NG	OK/NG	OK/NG	OK/NG



**SPECIFICATIONS OF SCANNING SONAR  
CSH-10**

**1 GENERAL**

- 1.1 Scanning method Full digital beam forming
- 1.2 Frequency 83.5 kHz (selectable between 81.5 and 85.5 kHz)
- 1.3 Power output 214 ± 2.0 dB $\mu$ Pa
- 1.4 Pulse length 0.5 to 20 ms

1.5 Range

Basic range (m)	Range (m)		Basic range (m)	Range (m)	
	Off-center 'OFF'	Off-center 'ON'		Off-center 'OFF'	Off-center 'ON'
50	0-50	0-90	800	0-800	0-1280
100	0-100	0-160	900	0-900	0-1440
150	0-150	0-240	1000	0-1000	0-1600
200	0-200	0-320	1100	0-1100	0-1760
300	0-300	0-480	1200	0-1200	0-1920
400	0-400	0-640	1400	0-1400	0-2000
500	0-500	0-800	1600	0-1600	0-2000
600	0-600	0-960	2000	0-2000	0-2000
700	0-700	0-1120			

- 1.6 Audio search Frequency: 1 kHz, Output 10 W (optional speaker required)

**2 PROCESSOR UNIT**

- 2.1 Orientation Head-up, North-up\* and Course up\* (\*: sensor required)
- 2.2 Display mode Horizontal single display, Fish finder combination
- 2.3 Marks Own ship, Bow line, Bearing/Distance, Event, Fish school, Bearing scale, Tracking, Current
- 2.4 Information Scan (Bearing/Distance), Cursor (Distance/Depth/Bearing), Event, Fish school (Position/Bearing), Own ship's location, Speed/Bearing, Water temperature
- 2.5 Features Interference rejecter, Echo average, Noise limiter, Signal level, Automatic target tracking, Auto-retraction, Fish school alarm
- 2.6 Resolution 1280 x 1024 (SXGA)
- 2.7 Picture color 32 colors (sonar pictures), 6/10 colors (marks)

**3 HULL UNIT**

- 3.1 Transducer travel 400 mm or 600 mm
- 3.2 Raise/lower time 7 s (400 mm travel), 10 s (600 mm travel)
- 3.3 Tx beam width Horizontal: 360°, Vertical: 6° (-3 dB at 83.5 kHz)
- 3.4 Rx beam width Horizontal: 10°, Vertical: 9° (-3 dB at 83.5 kHz)
- 3.5 Ship's speed allowance 20 kn (18 kn for raise/lower operation)

**4 INTERFACE**

- 4.1 Number of ports
  - Video output 2 port, HDMI
  - NMEA0183 5 ports, V1.5/2.0/3.0/4.0/4.1
  - External KP 2 ports
    - Output 1: current loop or contact closure (12 V positive)
    - Input 1: current loop or contact closure (5-12 V positive)

Audio output	1 port, 10 W, 4 ohms, monaural
Gyrocompass	1 port, AD-10
Echo sounder input	1 port, VI-1100A (analog)
Contact closure	1 port, for remote control or external switch
USB	4 ports, USB2.0: 2 ports, USB3.0: 2 ports
LAN	2 ports, Ethernet, 10/100/1000Base-T
4.2 Data sentences	
Input	CUR, DBS, DBT, DPT, GGA, GLL, GNS, HDG, HDM, HDT, MDA, MTW, RMC, VBW <sup>*1</sup> , VDR, VHW, VTG, ZDA
Output	TLL
	*1: fore-aft/port-stbd speed data required
4.3 Output proprietary sentence	
PFEC	evt, fkv, fmg, fvc, pidat, sht, tfm, tlm, tqm

## 5 POWER SUPPLY

5.1 Transceiver unit	24 VDC, 7.2 A max, transmit 15 Apeak (2 ms), rush current: 11 Apeak, effective current: 6.5 Arms (144 W)
5.2 Processor unit	12-24 VDC: 4.0-2.0 A, average: 3.4-1.7 Arms (41 W)
5.3 Hull unit	24 VDC, 10 A max, raise/lower drive: 6 Arms (144 W), start-up: 44 Apeak (160 ms)

## 6 ENVIRONMENTAL CONDITIONS

6.1 Ambient temperature	
Processor/ Transceiver unit	-15°C to +55°C
Transducer	-5°C to +35°C
Hull unit	0°C to +55°C
Control unit/ Small switch box/ Remote controller	-15°C to +55°C
6.2 Relative humidity	93% or less at +40°C
6.3 Degree of protection	
Transducer	IPX8
Control unit	IP22 (tabletop mount), IP25 (flush mount)
Processor/ Transceiver unit	IP22
Hull unit	IPX2
Remote controller	IPX4 (FSV-854-MK2), IP56 (SCU-001)
Small switch box	IP56 (front), IP22 (rear)
6.4 Vibration	IEC 60945 Ed.4

## 7 UNIT COLOR

7.1 Processor unit	N2.5
7.2 Transceiver unit	N2.5, N9.5
7.3 Control unit	N1.0
7.4 Hull unit	N2.5

# INDEX

- A**
- AGC ..... 2-2
  - Alarm ..... 10-10
  - Audio bearing ..... 3-3
  - Audio function ..... 3-3
  - Audio volume ..... 3-4
  - Automatic tilt function ..... 1-16
- B**
- Beamwidth ..... 2-6
  - Board test ..... 10-16
  - Brilliance ..... 1-10
- C**
- Characters ..... 1-8
  - Color curve setting ..... 9-4
  - Control unit ..... 1-1
    - FSM-854-MK2 ..... 1-3
    - SCU-001 ..... 1-3
    - SCU-002 ..... 1-1
    - SCU-003 ..... 1-4
  - Course-up ..... 1-13
- D**
- Delete data ..... 7-7
  - Distance unit (fish finder) ..... 9-10
  - Distance unit (sonar) ..... 9-10
- E**
- Error code list ..... AP-5
  - External data input ..... AP-8
- F**
- Fan monitor test ..... 10-17
  - Far Gain ..... 2-1
  - Fish alarm ..... 3-5
  - Fish finder ..... 4-1
    - Clutter rejection ..... 4-5
    - Depth/distance measurement ..... 4-4
    - Gain ..... 4-2
    - Interference rejector ..... 4-5
    - Picture advance speed ..... 4-3
    - Weak echo deletion ..... 4-6
  - FISH marks
    - deleting individual ..... 3-8
  - Fish mode ..... 3-1
  - Function keys ..... AP-1
- I**
- Initial setting menu ..... 9-9
  - Interference rejector
    - sonar ..... 2-4
    - Sounder ..... 4-3
- K**
- Key beep volume ..... 9-10
- M**
- Maintenance ..... 10-1
    - Hull unit maintenance ..... 10-2
    - Trackball maintenance ..... 10-7
  - Mark menu ..... 9-6
  - Menu operation ..... 1-5
  - Menu tree ..... AP-1
  - Motion ..... 7-5
    - Delete motion images ..... 7-7
    - Play back motion images ..... 7-6
    - Save motion images ..... 7-5
- N**
- NavNet sync mark ..... 1-13
  - Near Gain ..... 2-1
  - Net course mark ..... 3-13
  - Noise limiter ..... 2-4
  - Noise suppression ..... 2-2
  - North-up ..... 1-13
  - Numeric and graphic data display area ..... 5-1
- O**
- Off-center ..... 3-8
  - Operation test ..... 10-13
  - Option list ..... 9-9
  - Own ship mark ..... AP-8
  - Own ship track ..... 1-13
- P**
- Panel dimmer ..... 1-10
  - Panel test ..... 10-18
  - Pulse length ..... 2-2
- R**
- Range ..... 4-1
    - Sonar ..... 1-14
  - Record and play data ..... 7-1
    - Delete files ..... 7-7
    - Motion image ..... 7-5
    - Still image ..... 7-2
  - Record menu ..... 9-8
  - Registered remote control list ..... 9-10
  - Remote control status ..... 9-10
  - Remote controller ..... 1-3
    - FSV-854-MK2 ..... 1-3, 6-7
    - SCU-001 ..... 1-3, 6-7, 10-19
  - Remote controller test ..... 10-19
  - Remote key setting ..... 9-9
- S**
- SCU-001 ..... 1-3
    - Function key ..... 6-7
    - Overview ..... 1-3
    - Paring ..... 6-8
    - Status ..... 6-9
    - Test ..... 10-19

## INDEX

Small switch box .....	1-4
Software function keys .....	1-20
Speaker volume .....	9-10
Status messages .....	10-12
STC .....	4-8
System configuration .....	xiii
System menu .....	9-8

### **T**

Target lock .....	3-1
Test menu .....	9-8, 10-12
Tilt indication .....	1-16
Trackball mark .....	1-20
Trackball speed .....	9-10
Transmission pulse .....	4-8
Troubleshooting .....	10-9
TRX position indicator .....	1-9
TVG .....	4-6
TX and RX .....	4-8
TX cycle .....	2-5

### **U**

Useful functions .....	6-1
Bluetooth settings .....	6-7
Function keys .....	6-1
Remote controller .....	6-7
User programs .....	6-3
User program control .....	6-4
User program menu .....	6-4
User program registration .....	6-4

### **W**

Warnings .....	10-10
----------------	-------



## Declaration of Conformity



We **FURUNO ELECTRIC CO., LTD.**

(Manufacturer)

9-52 Ashihara-Cho, Nishinomiya City, 662-8580, Hyogo, Japan

(Address)

declare under our sole responsibility that the product

**SCANNING SONAR CSH-10**

(Model name, type number)

to which this declaration relates conforms to the following standard(s) or other normative document(s)

### EU

EMC Directive 2014/30/EU

IEC 60945 Ed.4.0: 2002

For assessment, see

- Test report  
Labotech International Co., Ltd.  
LIC 12-23-140, 8 Dec 2023

### UK

SI 2016 No.1091 EMC Regulations 2016 as amended

EN 60945: 2002

For assessment, see

- Test report  
Labotech International Co., Ltd.  
LIC 12-23-140, 8 Dec 2023

(title and/or number and date of issue of the standard(s) or other normative document(s))

On behalf of Furuno Electric Co., Ltd.

Nishinomiya City, Japan  
30 January 2024

(Place and date of issue)

Akihiko Kanechika  
Department General Manager  
Quality Assurance Department

(name and signature or equivalent marking of authorized person)